



**OPERATION INSTALLATION MAINTENANCE  
MANUAL  
FOR SAM BOOST™ WITH SMART NOZZLE N<sub>2</sub>P**



BY

Akron Brass, INC.

A Unit of IDEX Corporation

1615 Old Mansfield Road, Wooster, OH 44691

(800) 288.1161

[www.akronbrass.com](http://www.akronbrass.com)



MANUAL P/N: FSG-MNL-00232 Revision B

COPYRIGHT © 2022 - 2023 BY HALE PRODUCTS, INC. ALL RIGHTS RESERVED



# SAM BOOST™ WITH SMART NOZZLE N<sub>2</sub>P INSTALLATION, OPERATING, & MAINTENANCE MANUAL

## Contents

1. SAFETY .....	3
2. GENERAL INSTRUCTIONS .....	3
3. WHAT'S INCLUDED.....	4
3.1 SAM Boost™ Electronic Components .....	6
3.2 SAM Boost™ Valves & Venting Components.....	6
3.3 SAM BOOST™ Example Build.....	7
3.4 Assembly Diagram.....	8
4. OVERVIEW .....	9
4.1 SMART NOZZLE OVERVIEW.....	9
4.2 BATTERIES AND CHARGER OVERVIEW .....	11
4.3 DISPLAY OVERVIEW .....	12
4.4 DISCHARGE VALVE OVERVIEW .....	12
4.5 TANK-TO-PUMP OVERVIEW .....	13
4.6 NOZZLE RADIO OVERVIEW.....	14
4.7 MATRIX GOVERNOR OVERVIEW.....	15
4.8 CAN DISTRIBUTION MODULE AND WIRING HARNESS OVERVIEW .....	16
5. Installation.....	17
5.1 HARNESS INSTALLATION BEST PRACTICES .....	18
5.2 RADIO MODULE INSTALLATION .....	19
5.3 ANTENNA INSTALLATION .....	20
5.4 DISCHARGE VALVE INSTALLATION .....	22
5.5 TANK-TO-PUMP VALVE INSTALLATION .....	24
5.6 CAN NETWORK HUB INSTALLATION.....	26
5.7 PANEL COMPONENTS INSTALLATION.....	27
5.7.1 SAM BOOST™ DISPLAY INSTALLATION .....	27
5.7.2 WARNING LABEL & COVER PLACARD INSTALLATION .....	30
5.8 MATRIX MODULE INSTALLATION .....	31
5.8.1 Pressure Transducer Installation .....	32
5.9 WATER TANK COMPONENT INSTALLATION .....	33
5.9.1 PUMP VENTING SOLENOID INSTALLATION .....	33
5.9.2 SAM BOOST™ TANK ASSEMBLY INSTALLATION .....	34
6. OPERATION.....	35
6.1 SAM BOOST™ SCREEN LAYOUT.....	35
6.1.1 Home Page .....	35
6.1.2 Discharge Valve Page .....	38
6.2 SAM BOOST™ Standard Operation .....	39
6.2.1 Pump Engagement .....	39
6.2.2 Smart Nozzle Status Indicators.....	39

PHONE: (800) 288.1161

[www.akronbrass.com](http://www.akronbrass.com)



# SAM BOOST™ WITH SMART NOZZLE N<sub>2</sub>P INSTALLATION, OPERATING, & MAINTENANCE MANUAL

6.2.2.1	Smart Nozzle Error Status .....	40
6.2.3	CHARGING THE HOSE FROM THE SAM™ SMART NOZZLE .....	41
6.2.4	Hydrant/Draft Changeover .....	42
6.2.5	SAM Smart Nozzle Override .....	43
6.2.6	Discharge Valve Manual Override .....	43
6.2.7	System Shut Down.....	44
6.3	System Operational Warnings .....	45
6.3.1	Standard warnings .....	45
6.3.2	Decision warnings .....	46
6.3.2.1	LOW NOZZLE PRESSURE Warning .....	46
6.3.2.2	SWITCHING GOVERNOR MODES Warning.....	47
6.3.2.3	DECREASE GOVERNOR PRESSURE Warning.....	47
6.3.2.4	SWITCHING MODES Warning.....	47
6.3.2.5	ENABLE AUTO PRESSURE CONTROL Warning.....	47
6.4	CHECKING BATTERY CHARGE LEVEL & WI-FI STRENGTH .....	47
7.	Passwords and Calibrations .....	49
7.1	Entering Passwords.....	49
7.2	Governor settings (Password 00311) .....	50
7.2.1	Engine Settings .....	51
7.2.1.1	Changing the Display's Baud Rate .....	51
7.2.1.2	Changing the Engine Control type .....	51
7.2.1.3	Ford Engine Control Settings .....	51
7.2.1.4	Analog Engine Control Settings .....	52
7.3	SAM Smart Nozzle Settings (00401) .....	52
7.4	Water Calibration Page (Password 08265).....	53
7.5	Valve Position Calibration Page (Password 08266) .....	54
7.6	Valve Pressure Calibration Page (Password 08265).....	55
7.7	SAM Smart Nozzle Pairing (Password 10600) .....	56
7.8	SAM Smart Nozzle Flow Calibration (Password 10610).....	57
8.	FINAL COMMISSIONING CHECKLIST .....	58
9.	MAINTENANCE.....	59
9.1	Nozzle and Nozzle Tip Maintenance .....	59
9.2	Battery Maintenance.....	59
9.2.1	CHARGING BATTERIES.....	59
9.2.2	INSTALLING BATTERIES .....	60
9.2.3	STORING BATTERIES.....	60
9.2.4	DISPOSING OF BATTERIES .....	60
9.2.5	SAFETY .....	61

PHONE: (800) 288.1161

[www.akronbrass.com](http://www.akronbrass.com)







# SAM BOOST™ WITH SMART NOZZLE N<sub>2</sub>P INSTALLATION, OPERATING, & MAINTENANCE MANUAL

9.3	Akron Valve Maintenance.....	61
9.3.1	Akron Valve Exercise .....	61
9.3.2	Akron Valve Pressure Calibration .....	61
9.4	Pump Vent Solenoid Maintenance .....	62
9.5	Master Pressure Transducer Maintenance.....	62
9.6	Tank Level Sensor Maintenance .....	63
10.	REPLACEMENT PARTS .....	63
11.	MANUFACTUER INFORMATION & WARRANTY .....	63
11.1	MANUFACTURER'S INFORMATION .....	63
11.2	WARRANTY .....	64
12.	PRODUCT RATINGS .....	64
12.1	FCC NOTICES .....	64
12.2	ISED NOTICE (ENGLISH & FRENCH) .....	65

## 1. SAFETY

Safety is the first priority for all involved. Firefighting is an inherently risky activity and all precautions should be taken to minimize that risk. The definitions of safety headings are shown below. Read and understand all operating instructions and Standard Operating Guidelines (SOG) provided by the Authority Having Jurisdiction (AHJ).

	<ul style="list-style-type: none"> <li>Indicates a hazardous situation which, if not avoided, WILL result in death or serious injury.</li> </ul>
	<ul style="list-style-type: none"> <li>Indicates a hazardous situation which, if not avoided, COULD result in death or serious injury.</li> </ul>
	<ul style="list-style-type: none"> <li>Indicates a potentially hazardous situation which, if not avoided, may result in minor or moderate injury.</li> </ul>
	<ul style="list-style-type: none"> <li>Addresses practices not related to personal injury.</li> </ul>

## 2. GENERAL INSTRUCTIONS

This manual covers the SAM BOOST™ with SMART NOZZLE N<sub>2</sub>P Technology when local procedures do NOT exist. Basics of SMART NOZZLE operation, installation verification, preventive maintenance, and operator-based troubleshooting are covered herein.

**IMPORTANT: PLEASE READ THESE INSTRUCTIONS CAREFULLY, NOTE THE SAFE OPERATIONAL REQUIREMENTS, WARNINGS, AND CAUTIONS. USE THIS PRODUCT CORRECTLY, AND WITH CARE FOR THE PURPOSE FOR WHICH IT IS INTENDED. FAILURE TO DO SO MAY CAUSE DAMAGE OR PERSONAL INJURY AND WILL INVALIDATE THE WARRANTY!**



Firefighters should be fully trained and ready to operate in manual mode without delay in operations or any compromise to safety.

PHONE: (800) 288.1161

[www.akronbrass.com](http://www.akronbrass.com)

### 3. WHAT'S INCLUDED

For full system layout reference Hale Drawing **FSG-PL-01530**. SAM Boost™ System comes delivered in one box. Summary of included items are as followed:

#### SAM Boost™ Electronic Components

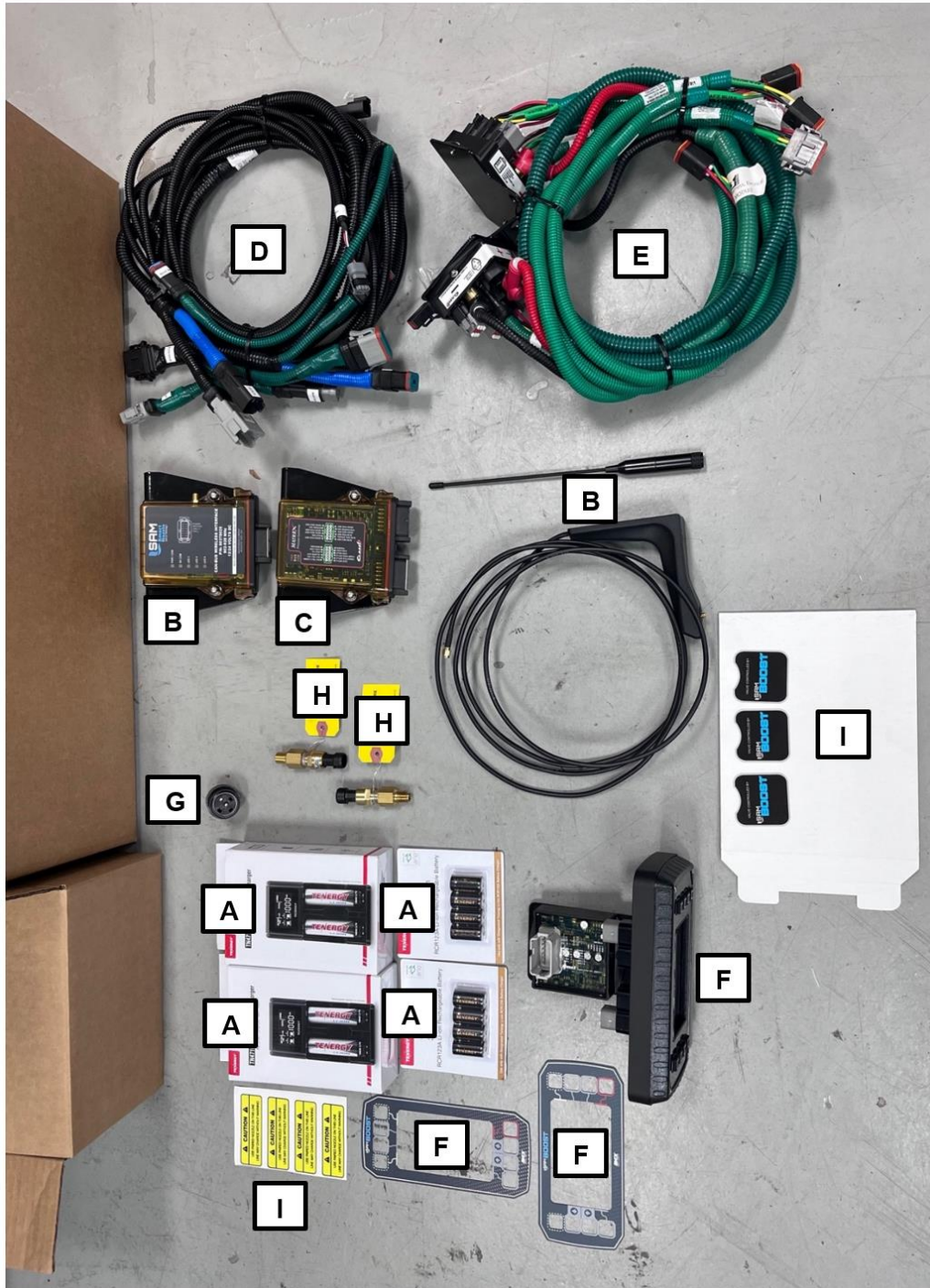

PHONE: (800) 288.1161

[www.akronbrass.com](http://www.akronbrass.com)



**SAM Boost™ Valves & Venting Components**

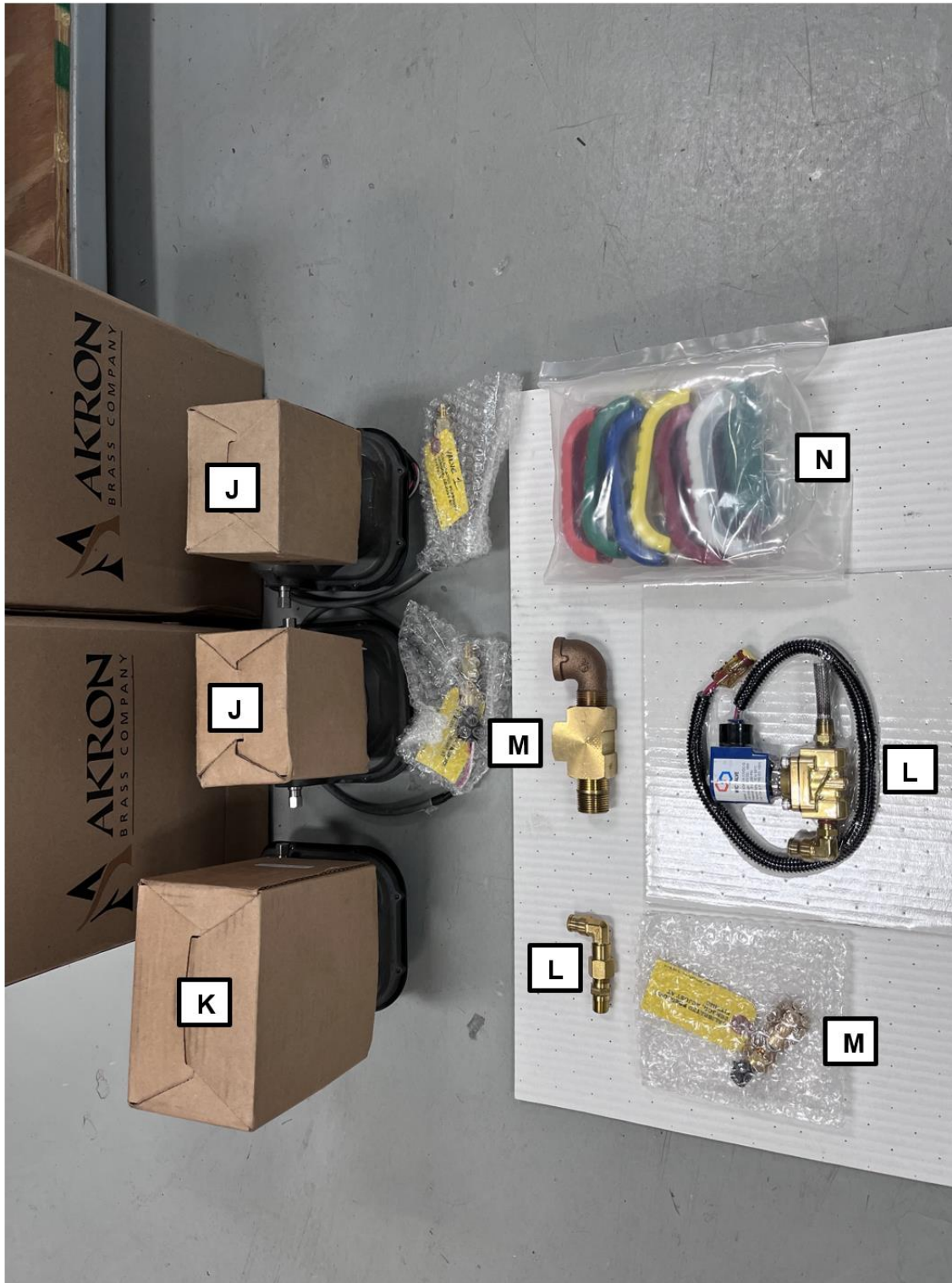

PHONE: (800) 288.1161

[www.akronbrass.com](http://www.akronbrass.com)



## SAM BOOST™ WITH SMART NOZZLE N<sub>2</sub>P INSTALLATION, OPERATING, & MAINTENANCE MANUAL

### 3.1 SAM Boost™ Electronic Components

- A. Batteries & Battery Chargers
  - Four batteries per nozzle-Tenergy 750 mAh Li-ion rechargeable type
- B. Wireless CAN Module & Antenna
- C. Matrix Governor
- D. SAM Boost™ System Harness
- E. Cross Pump Backbone Harness with CAN Distribution Module
  - Two CAN Distribution Modules provided.
- F. SAM Boost™ Display, Power Module, & Adapter Plate
- G. Alarm Buzzer (Optional)
- H. Master Intake & Master Discharge Pressure Sensors
- I. Caution Labels & Push-Pull Cover Placards

### 3.2 SAM Boost™ Valves & Venting Components

- j. SAM™ Smart Nozzle
  - Customer Specified, Turbojet™, Assault™, etc. at rated operating pressure
- k. 2" Preconnect Boost™ Valves, Pressure Sensors, & Valve Harnesses
- l. Tank-to-Pump Boost™ Valve & Valve Harness
  - Customer Specified, 3" or 4" Valve Size Available
- m. Pump Venting Solenoid & Fittings
- n. Water Tank Level Sensor & Fittings
- o. Nozzle Color Handle Kit

PHONE: (800) 288.1161

[www.akronbrass.com](http://www.akronbrass.com)

### 3.3 SAM BOOST™ Example Build

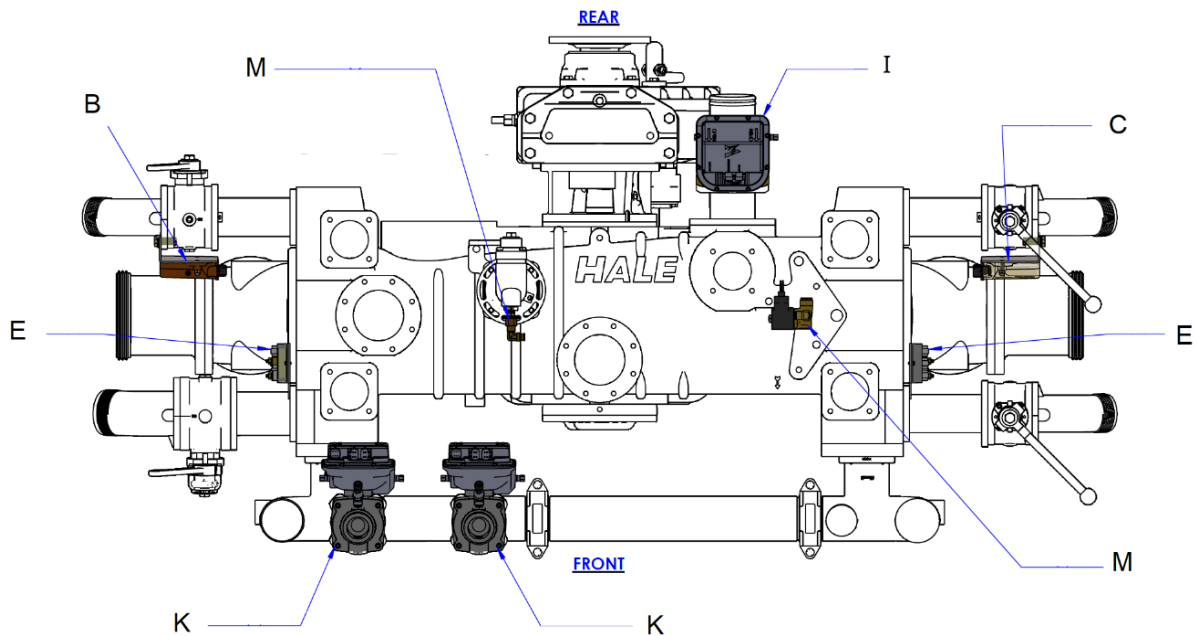

PHONE: (800) 288.1161

[www.akronbrass.com](http://www.akronbrass.com)



## 3.4 Assembly Diagram

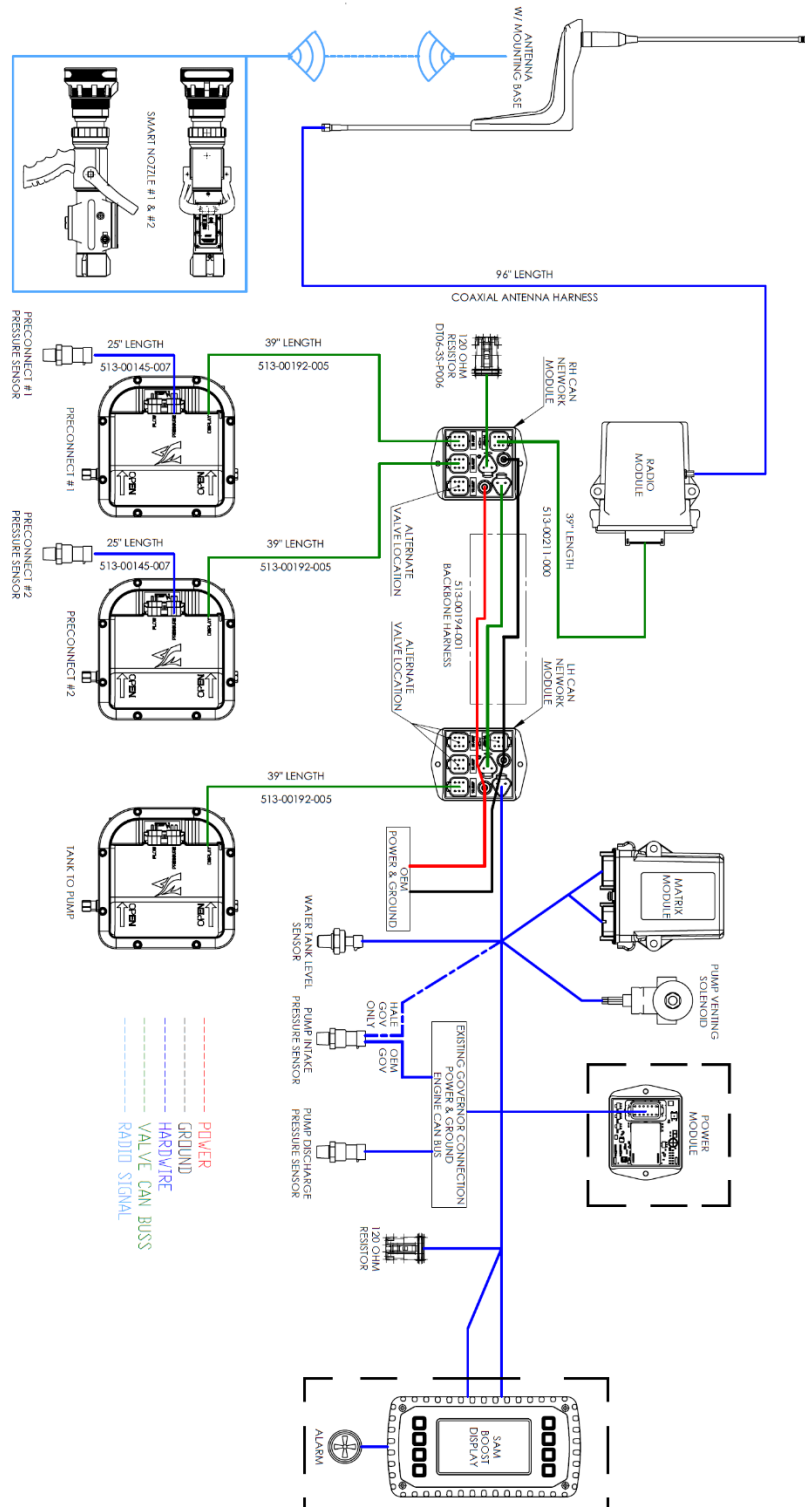

\*Items in dotted line boxes may vary per customer order

PHONE: (800) 288.1161

[www.akronbrass.com](http://www.akronbrass.com)



## SAM BOOST™ WITH SMART NOZZLE N<sub>2</sub>P INSTALLATION, OPERATING, & MAINTENANCE MANUAL

### 4. OVERVIEW



Firefighting is an inherently risky activity. Understand operation and limitations of equipment and check for flow before entering any Immediately Dangerous to Life and Health (IDLH) environment. Follow all training and guidelines from the Authority having Jurisdiction. (AHJ).

The SAM BOOST™ system has two SAM™ SMART NOZZLES. These nozzles allow for the user to charge the line remotely. The nozzles are paired to two SAM enabled discharge valves that have the capability to close loop pressure control the line. Activating a discharge line using the SAM™ SMART NOZZLE will automatically increase the pump pressure and line pressure until the rated nozzle pressure is achieved.

The SAM BOOST™ system also acts as a normal NFPA compliant pressure governor capable of operating in RPM and PSI engine control modes. It also includes an integrated tank-to-pump valve that will automatically open with pump engagement and can be controlled via the display.

#### 4.1 SMART NOZZLE OVERVIEW

The SAM™ SMART NOZZLE allows the pre-connected hose line paired to the nozzle to be charged from the nozzle itself. The SAM™ SMART NOZZLE is designed for use with pre-connected hose lines up to 300 feet in length. After charging the hose line from the nozzle, the system will adjust the valve position and the pump pressure to attain the rated pressure for the rated flow at the nozzle using a pressure sensor at the nozzle.

When there is a restriction in flow, that reduces the nozzle pressure, then SAM Boost™ will increase the pressure at the truck (up to the NFPA compliant limit for pressure spikes) and will automatically and warn the operator if desired pressure is not automatically obtained. This system delivers target flows without guesstimates at the pump panel.

#### NOTICE

Since the SAM™ SMART NOZZLE senses pressure, the typical manual estimates for friction loss and elevation are not needed. The nozzle will deliver its rated flow and pressure which may be higher than previous SOG provided and additional nozzle reaction may be noticeable.

The nozzles which the SAM™ SMART NOZZLE module can be integrated with include the Turbojet™, Assault™, and Pyrolite shutoffs with smoothbore nozzles. The specified combination nozzle operating pressure can be 50, 75, or 100 psi depending on the nozzle and customer requirements. The SAM™ SMART NOZZLE module and customer specified nozzle come completely assembled, ready to use with the properly configured SAM™ SMART NOZZLE system installed in the truck. The system will support up two separate nozzles equipped with the SAM™ SMART NOZZLE module at the same time.

The SAM™ SMART NOZZLE also contains a tank level gage that shows the water level in the booster tank on the truck. This water level is continually updated. The water level gage turns blue when no longer running from tank and running from an external water supply. Additionally, the level gage goes dark if wireless communication is lost with the truck. The nozzle display also shows a single red, slow blinking LED when there is an issue at the truck exists that can prevent the valve from opening. The nozzle firefighter can see what is happening at the nozzle and the digital radio sends data back to the truck that the pump operator can use.

Unique to the SAM™ SMART NOZZLE is an integrated pressure transducer. The transducer is used to send the nozzle inlet pressure back to the SAM™ truck via digital radio. This closed loop system maintains the proper nozzle pressure automatically.

PHONE: (800) 288.1161

[www.akronbrass.com](http://www.akronbrass.com)



## SAM BOOST™ WITH SMART NOZZLE N<sub>2</sub>P INSTALLATION, OPERATING, & MAINTENANCE MANUAL

### **⚠ WARNING**

The SAM™ SMART NOZZLE is paired to a single discharge valve. Do not place the nozzle on a different discharge valve as doing so can result in the opening of the wrong discharge valve which may cause bodily injury.

Since the SAM™ SMART NOZZLE is paired to a single discharge the Akron nozzle color kit should be matched to the discharge color code to help make sure the nozzle and its paired discharge are readily identified

The screen on the truck can show the pressure at the nozzle in addition to friction loss, signal strength, and battery condition. This information is available for each nozzle being used individually on the truck mounted display screen(s).

<b>SAM SMART NOZZLE SPECIFICATIONS</b>	
Max Pressure	230 PSI
Max Distance	300ft of preconnected hose*
Battery Life	Up to 8 hours
Rated Tip Pressure	50, 75, or 100 (customer specified)
Nozzle Type	Akron Turbojet™, Assault™, and Pyrolite shutoffs with smoothbore nozzles
Inlet size	1.5 inch
Pistol Grip	Pistol grip is optional
Color	Red, orange, yellow, blue, green, white, and black.

\* Max distance can be reduced by environmental conditions

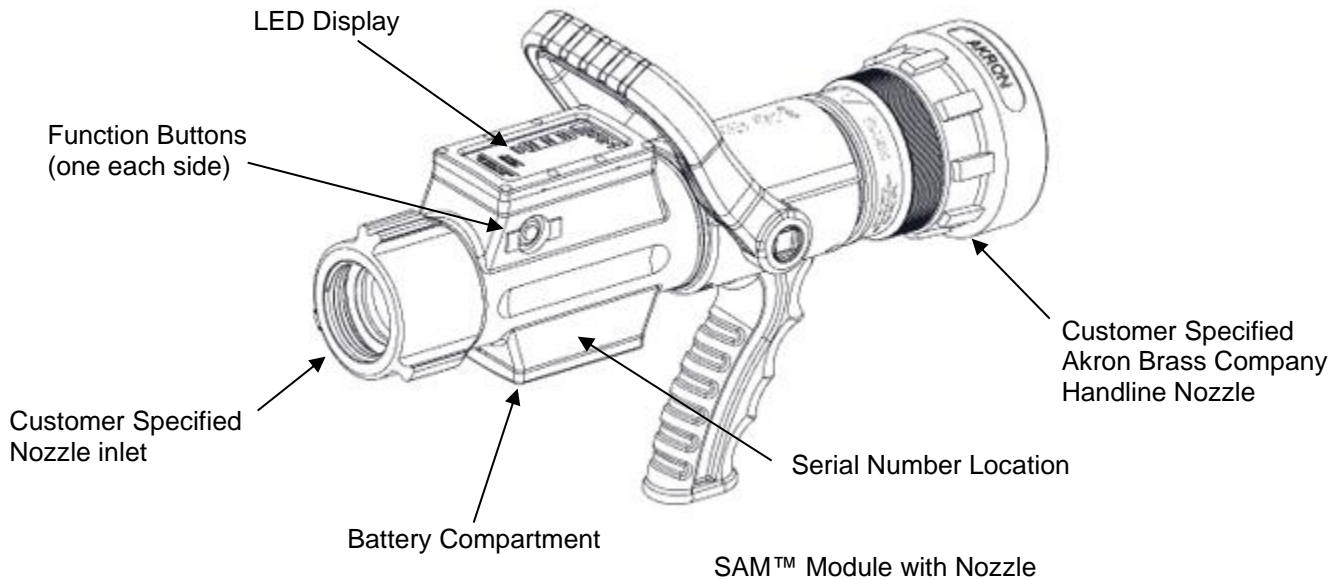

PHONE: (800) 288.1161

[www.akronbrass.com](http://www.akronbrass.com)

## 4.2 BATTERIES AND CHARGER OVERVIEW



The SAM™ SMART NOZZLE comes with Lithium-ion rechargeable batteries. The batteries must be fully charged prior to first use and will last approximately 8 hours of pumping. Use the battery charger supplied.

### **WARNING**

Read and follow all battery safety instructions located inside battery and charger packaging

### **WARNING**

Using any battery or battery charger other than the ones supplied can hamper performance or potentially damage your SAM™ SMART NOZZLE or batteries. Failure to use the specified equipment increases the chance of fire and will void your warranty.

The user must tap a button on the nozzle to wake it up. If the pump is engaged, then the nozzle will stay awake. The nozzle will automatically turn on when the pump is disengaged. If the user taps a button while the pump is disengaged, then the nozzle will fall back to sleep after one minute.

## 4.3 DISPLAY OVERVIEW

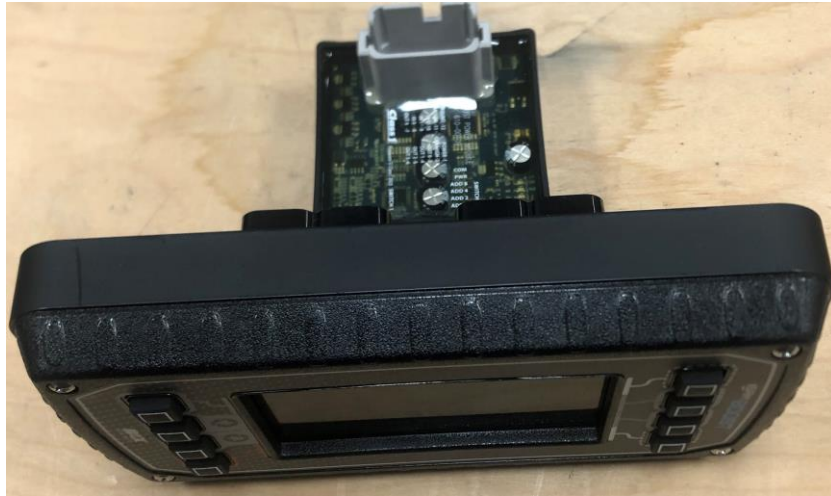

Typical display shown

The SAM BOOST™ system comes with a display that will replace the existing governor on the truck. The SAM BOOST™ display allows for the following:

- Discharge valves status
- Discharge valves control
- Tank-to-pump control
- Tank-to-pump status
- Engine Information and control.
- SAM™ SMART NOZZLE Status
- SAM BOOST™ System Status

The SAM BOOST™ display has an integrated backlight and polarized screen to allow for better screen visibility in harsh environments. The display can be mounted vertically or horizontally, and the screen orientation can be changed via a password.

## 4.4 DISCHARGE VALVE OVERVIEW



PHONE: (800) 288.1161

[www.akronbrass.com](http://www.akronbrass.com)





## SAM BOOST™ WITH SMART NOZZLE N<sub>2</sub>P INSTALLATION, OPERATING, & MAINTENANCE MANUAL

The SAM BOOST™ system comes with two SAM™ SMART NOZZLE enabled discharge valves that can be controlled via the SAM BOOST™ display. These valves have electric actuators and are controlled by the SAM BOOST™ display. The valves have integrated pressure transducers to read individual line pressure. The valves have 3 modes: SAM™ SMART NOZZLE mode, SAM mode, and manual mode.

### SAM™ SMART NOZZLE Mode

The valve will automatically adjust (in conjunction with governor) to maintain desired nozzle pressure. The valve is in this mode when there is a nozzle icon on the associated valve set pressure.

### SAM Mode

The valve will automatically adjust (in conjunction with governor) to maintain desired line pressure. The valve is in this mode when there is a set pressure on the associated valve.

### Manual Mode

The valve will adjust to user desired valve position. The valve is in this mode when there is a “MANUAL MODE” icon next to the associated valve.



Valve handle will automatically rotate while in SAM™ SMART NOZZLE Mode or SAM Mode and poses an entanglement risk. Keep hands clear. Remove power from valve before trying to manually override via the override knob.

## 4.5 TANK-TO-PUMP OVERVIEW



The SAM BOOST™ system provides an electric tank-to-pump valve that is controlled via the SAM BOOST™ display. This valve will automatically open on pump engagement and will automatically close on pump disengagement.



Valve handle will automatically rotate while engaging or disengaging pump and poses an entanglement risk. Keep hands clear. Remove power from valve before trying to manually override via the override knob.

PHONE: (800) 288.1161

[www.akronbrass.com](http://www.akronbrass.com)



A pump venting solenoid is provided with the system that works in conjunction with the tank-to-pump valve. When the tank-to-pump valve is open, the solenoid will activate to vent out air that may be trapped inside the pump.



The pump venting solenoid does not act as a pump cooler. Please follow your jurisdiction's SOP for pump cooling and recirculation.

## 4.6 NOZZLE RADIO OVERVIEW



The SAM BOOST™ system provides a SAM™ SMART NOZZLE radio module and antenna. This module is how the display and the nozzles communicate with each other. The max range of communication is 300 ft. The nozzle and display will show radio communication status and indicate to the user if there are any issues.



Environmental conditions and obstructions may limit the max range of communication.

PHONE: (800) 288.1161

[www.akronbrass.com](http://www.akronbrass.com)

## 4.7 MATRIX GOVERNOR OVERVIEW



The SAM BOOST™ system provides a matrix governor module. This module is responsible for engine control, tank level readout, and master pump pressure regulation. A tank level sensor, master discharge pressure transducer, and master intake pressure transducer are also supplied.



### NOTICE

The master discharge/intake pressure transducers arrive from the factory calibrated. Only use the pressure transducers that have been provided.

### NOTICE

The tank level transducer is not calibrated, and user must calibrate tank level.

The matrix governor can operate the engine in either RPM or PSI control modes. In RPM mode, the matrix will maintain the engine speed at the user specified RPM. In PSI mode, the matrix will increase or decrease the engine speed to maintain the user specified pump pressure. The matrix governor can support different engine control styles and can operate at 125K, 250K, or 500K baud rate.

PHONE: (800) 288.1161

[www.akronbrass.com](http://www.akronbrass.com)

## 4.8 CAN DISTRIBUTION MODULE AND WIRING HARNESS OVERVIEW



The SAM BOOST™ system provides two CAN distribution modules. These modules distribute power and CAN communication to the nodes on the SAM BOOST™ system.



The SAM BOOST™ system also includes a set of harnesses that connect the nodes to the distribution modules.

PHONE: (800) 288.1161

[www.akronbrass.com](http://www.akronbrass.com)



## 5. INSTALLATION

It is recommended to plan the physical installation of the SAM Boost™ System by laying out all components included in the kit on the pump per the System Layout Drawing (FSG-PL-01530) and verify harnesses are within reach.

Items to consider before installation:

- Find optimal location of CAN Distribution hubs as harnesses only extend 39" from hub.
- Find optimal location for Antenna within 8' of Wire to Radio Module
- Lay out all components included in kit on pump as shown in System Drawing (FSG-PL-01530)
- Verify harnesses are within reach of components

### NOTICE

Do not extend provided harnesses without contacting technical support.

- Verify Truck/Engine Type is compatible with SAM Boost™. Compatible configurations listed below:
  - 2015 or newer Cummins CAN controlled Engine (500k Baud Rate)
  - 2012 or newer with Cummins CAN controlled Engine (250k Baud Rate)
  - 2001 or newer with Analog controlled Engine with J1939 engine data
  - 2019-2022 Ford OBDII (F550-650)
  - It is not an Aerial Apparatus
  - Apparatus is not utilizing FRC Datalink Network with the existing FRC governor.
  - Apparatus has Class1 TPG, TPG-A, Sentry or FRC Pump Boss PBA200-400 series Pump Pressure Governor



Class1 TPG, TPG-A



FRC Pump Boss



Class1 Sentry

Installation scope of work:

- Remove original discharge valves and controls
- Remove original tank-to-pump and controls
- Remove original governor display (leave harness intact)
- Mount new discharge valves w/pressure transducers
- Mount new tank-to-pump
- Mount new SAM BOOST™ display
- Mount CAN Distribution Hubs
- Mount Radio module and antenna.
- Mount Matrix module.
- Install new Master Pressure transducers.
- Install new Tank level sensor
- Install Pump vent solenoid.
- Install all harnessing
- Calibrate tank level
- Calibrate Nozzle Flow.

PHONE: (800) 288.1161

[www.akronbrass.com](http://www.akronbrass.com)



### 5.1 HARNESS INSTALLATION BEST PRACTICES

Most of the SAM BOOST™ components require a harness be connected to them. Please read the best practices listed below for optimal system performance and longevity:

- Provide a service loop to all connections- A service loop will provide strain relief to the connector if harness is pulled.

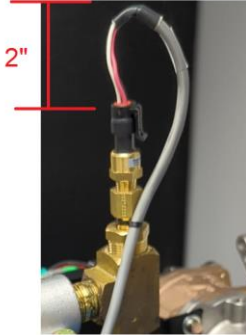

- Zip tie harness to stationary object in such a way that it creates a flexible 2" loop (shown above) behind the connector.
    - If loop is too tight it can have a detrimental effect by bending the seal on the connector.
- Orient all Pressure transducers so they are between 45 and 90 degrees from horizontal.
  - This will guarantee that the transducers will properly drain (protect from freezing) and will avoid the buildup of sediment.

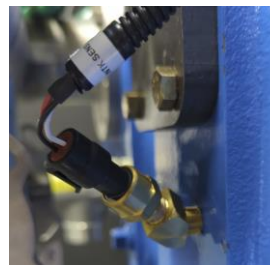

- Transducers include the following:
    - Master discharge and intake transducer
    - Valve discharge pressure transducer
    - Tank Level transducer.
- Orient all modules so that connectors are not facing up (to avoid accidental water intrusion). This rule applies to the following modules:
  - Matrix module
  - Radio module
  - Can Distribution modules
  - Discharge valves
  - Tank-to-pump valve

### 5.2 RADIO MODULE INSTALLATION

See plate drawing 546-00119-000 for radio module and antenna installation drawing.

The system includes an optional mounting bracket that can be installed to either a 2.5", 3", or 4" side discharge valve of the pump; however, location of the radio module is dependent on the location of the antenna with its coaxial cable. It is recommended to locate the antenna first and determine the cable length to the radio module is feasible before final mounting of the radio module. Avoid installing the radio module near power lines or equipment sensitive to noise. Follow the steps below to mount radio module

- Locate desirable location of module located 8' from the antenna and 39" from a CAN distribution hub.
  - Typically mounting the antenna to the pump house or the rear cab body will not require an extension as there is usually enough length to route back to the CAN Network Hub.
  - If required to mount the radio module beyond the provided length contact technical support
- Mount Module to Valve
  - Adapter fits 2.5", 3", or 4" Valves



#### **NOTICE**

It is recommended to install the module such that the electric connectors are oriented downward or sideways to avoid water build-up and intrusion

- Connect harness as shown on System Layout

PHONE: (800) 288.1161

[www.akronbrass.com](http://www.akronbrass.com)

### 5.3 ANTENNA INSTALLATION

See plate drawing 546-00119-000 for radio module and antenna installation drawing.

The antenna provided with the system includes an 8' length coaxial cable that connects to the radio module. This cable cannot be extended so plan for a proper installation location. Follow the steps below for antenna installation:

- Locate desired antenna location
  - The antenna should be located such that it clears the top of the cab and truck body, but away from any components that might interfere.
  - If antenna is on any surface that can tilt or move (for example tilt cab), verify there is sufficient length. Failure to account for this may damage the cable or other components when surface moves.
  - Antenna should be centered to provide equal coverage to all areas. See the examples below to see how biasing the antenna to one side/corner of the truck can cause uneven max nozzle range.

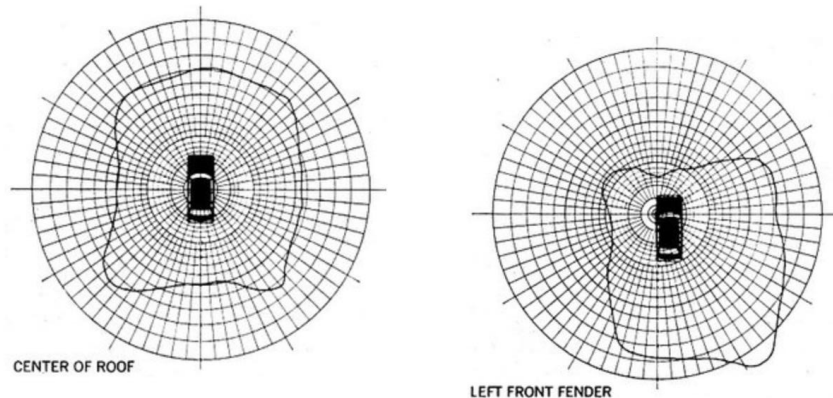

- Mount the Antenna using the two provided #8 screws .



PHONE: (800) 288.1161

[www.akronbrass.com](http://www.akronbrass.com)

- See the drawing below for the overall antenna size and mounting hole dimensions

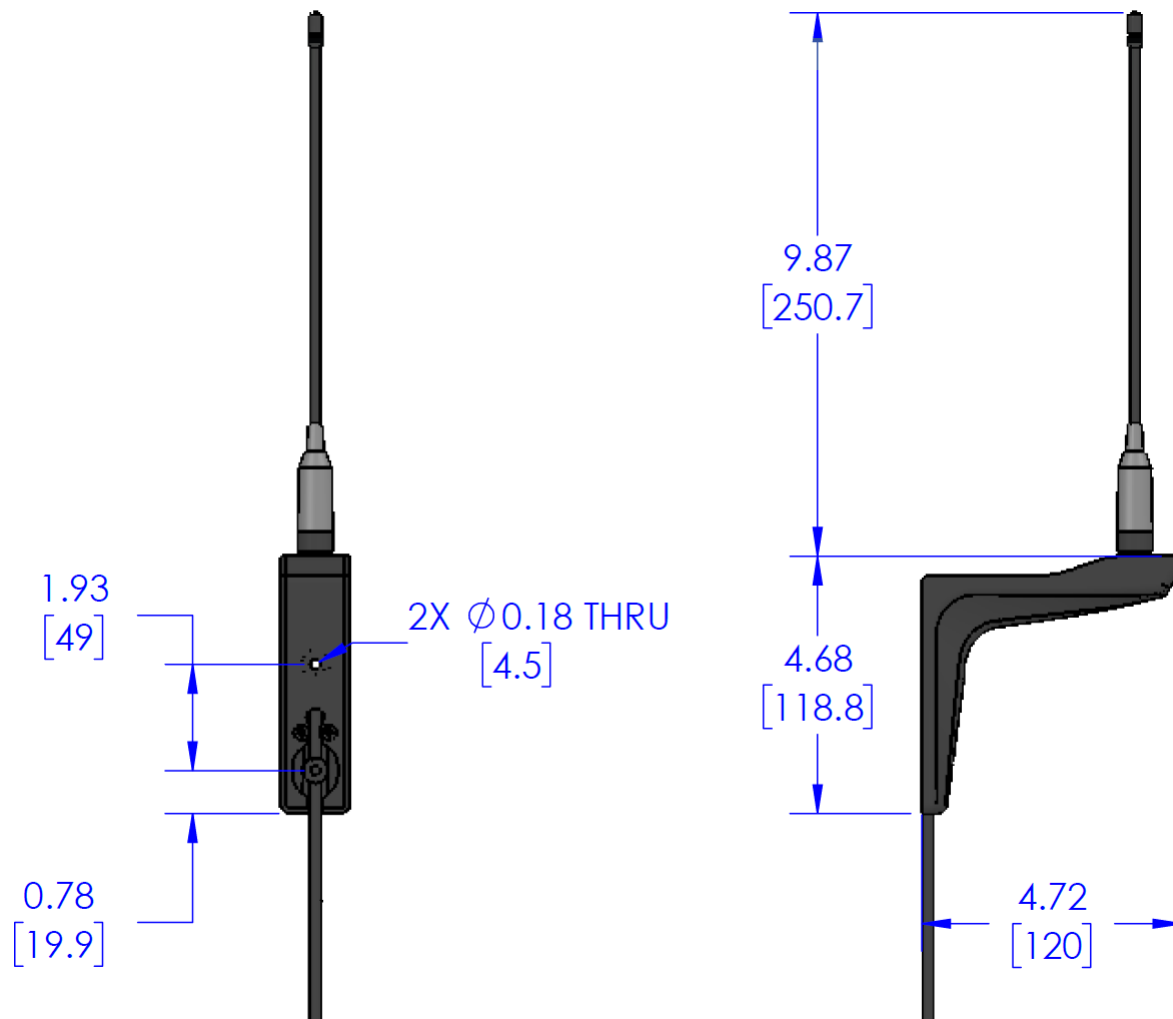

- Route the antenna wire
  - The coaxial cable cannot be shortened or lengthened with extensions.
  - Any excess length should be looped or coiled back and never folded to prevent damage to the cable.
  - When running the coaxial cable, use grommets when passing through walls, avoid sharp 90° bends of the cable, and use clips or wire-ties to secure the cable down.
- Connect the coaxial cable to the radio module
  - When connecting the coaxial cable to the radio module, do not overtighten beyond **8 – 8.5 IN-LBS** or risk damaging the connection port as shown in the next image.

PHONE: (800) 288.1161

[www.akronbrass.com](http://www.akronbrass.com)

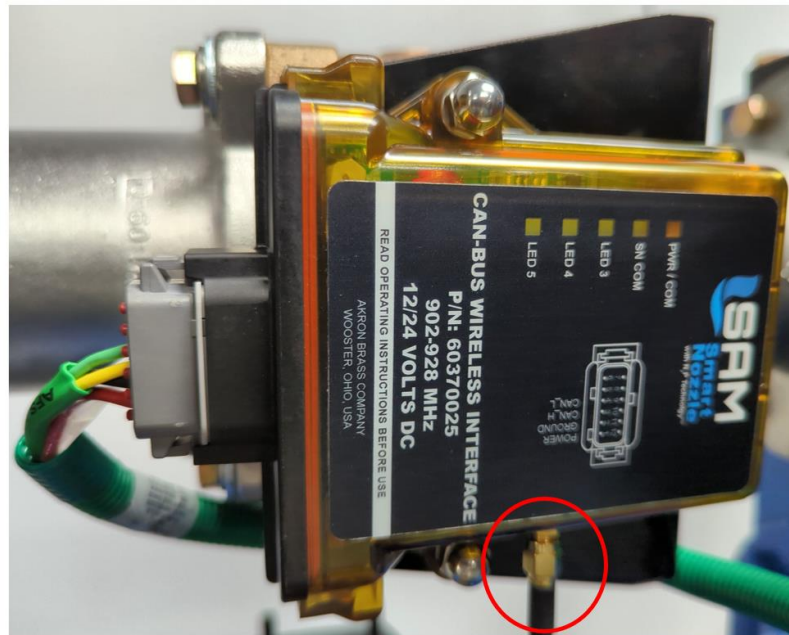

- Protection should be provided in front of the antenna whip to prevent damage from trees or overhead objects when the truck is in transit.

Refer to a certified RF Technician for installation recommendations on locating the antenna on the truck body. Consider other radio equipment to be mounted on the vehicle.

#### 5.4 DISCHARGE VALVE INSTALLATION

The SAM Boost™ System includes two 2" Electric Boost™ Valves programmed for use with SAM™ Smart Nozzles that have been paired and calibrated. Follow the steps below for valve installations

- Locate the original equipment valves.
- Remove their control elements at the valve & control panel
- Disconnect any gauge or drain lines at the original valves.
- Unbolt and remove original valves.
- Install the two 2" Electric Boost™ Valves at the original valve locations with the mechanical override accessible for use in emergencies.
  - Torque requirements for reattaching the valve adapters are 25 – 30 FT-LBS.
  - If clocking the valve is required, follow instruction on AKRON BRASS manual 127903

PHONE: (800) 288.1161

[www.akronbrass.com](http://www.akronbrass.com)





**NOTICE**

It is recommended to install the valve motor such that the electric connectors are oriented downward or sideways to avoid water build-up and intrusion. If the valve motor has been rotated, the position sensor will require calibration at the SAM Boost™ Display using password **08266**.

- Install the pressure transducers on the outlet side of the valve into drain Line or gauge Line. The pressure transducers are pre-installed with ¼" NPT adapters to prevent damage to the sensor from overtightening.
- Connect the transducers to the valve using harness 513-00145-007.
  - Provide a service loop to the harness as shown above.

PHONE: (800) 288.1161

[www.akronbrass.com](http://www.akronbrass.com)



## NOTICE

It is recommended to install the pressure transducer connectors oriented between 45° to 90° from the horizontal to allow drainage and avoid sediment build-up.

## 5.5 TANK-TO-PUMP VALVE INSTALLATION

The SAM Boost™ System includes a 3" or 4" Electric Boost™ Valve programmed for use with system. Follow the following for installation instructions.

- Locate the original equipment valve,
- Remove their control elements at the valve & control panel,
- Disconnect any drain lines as necessary.
- Remove original tank-to-pump valve.
- Install the Electric Boost™ Valve at the original valve locations with the mechanical override accessible for use in emergencies.
  - Torque requirements for reattaching the valve adapters are 34 – 38 FT-LBS for 3" Boost™ Valve, 60 – 70 FT-LBS for 4" Boost™ Valve.
  - If clocking the valve is required, follow instruction on AKRON BRASS manual 127903

PHONE: (800) 288.1161

[www.akronbrass.com](http://www.akronbrass.com)

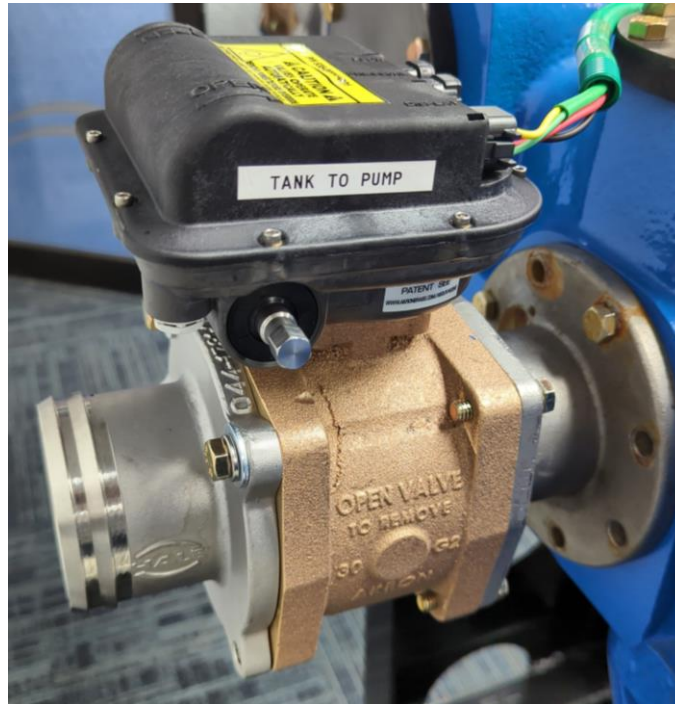

**NOTICE**

It is recommended to install the valve motor such that the electric connectors are oriented downward or sideways to avoid water build-up and intrusion. If the valve motor has been rotated, the position sensor will require calibration at the SAM Boost™ Display using password **08266**.



**NOTICE**

The 4" Electric Boost™ Valve is single directional and must be installed with the 250 PSI arrow pointing away from the pump.

- Install and connect to the CAN Network Hub using harness 513-00192-005.

PHONE: (800) 288.1161

[www.akronbrass.com](http://www.akronbrass.com)



### 5.6 CAN NETWORK HUB INSTALLATION

The SAM Boost™ System utilizes two preassembled CAN Network Hubs to connect all CAN enabled components. Locating each of the CAN Network Hubs will be dependent on the reach of each components' harness lengths, so preplanning is highly recommended. *FSG-PL-01530* shows a typical layout of the SAM Boost™ System but may not easily apply for all installations. Each hub includes a bracket for mounting with existing 7/16" fasteners. Follow the steps below for installation of the CAN Network Hub:

- Plan mounting location of CAN network Hubs
  - Recommended to have one located on passenger side and one on driver side of pump house.
  - To maintain J1939 Standards all CAN nodes must be within 39" of CAN Hub. Nodes are:
    - Discharge Valve 1
    - Discharge Valve 2
    - Tank-to-pump
    - Nozzle Radio Module
  - The harness that connects the hubs has a power leg (shown below) that must be connected to chassis power
    - Installer should plan on flipping hub placement so that the power leg is easily accessible on the driver side or passenger side of the truck.



- Example CAN Hub location shown below



- Once a viable location and orientation has been determined, torque the mounting fastener tightly until the assembly cannot rotate.

PHONE: (800) 288.1161

[www.akronbrass.com](http://www.akronbrass.com)

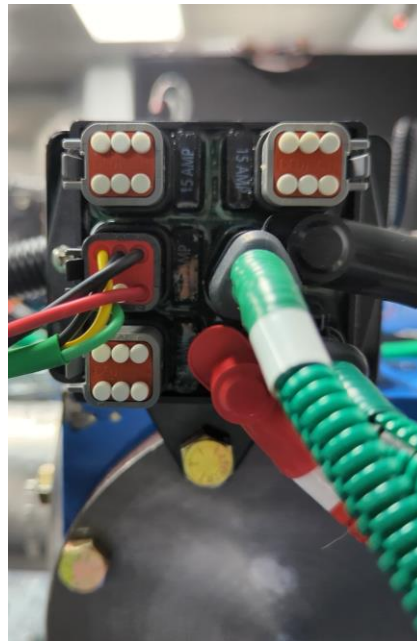

### NOTICE

It is recommended to install the CAN Network Hubs such that the electric connectors are oriented downward or sideways to avoid water build-up and intrusion.

- After the CAN Network Hubs have been installed, connect each of the harnesses to the CAN Network Hub nearest to the components. Any unused connection port should remain plugged to prevent water build-up and intrusion.
- Finally, connect chassis power & ground to the CAN Network Hub assembly to power the SAM Boost™ System.

### CAUTION

Do NOT wire to circuit with heavy motor loads such as the Primer or Foam System. Doing so may negatively affect overall system performance.

### NOTICE

It is recommended to wire to a switched power source with 30 AMP protection on the positive (+) side.

## 5.7 PANEL COMPONENTS INSTALLATION

The SAM Boost™ System includes the SAM Boost™ Display assembly and several labels & placards required for installation.

### 5.7.1 SAM BOOST™ DISPLAY INSTALLATION

See plate drawing FSG-PL-01530 for display overall dimensions.

The SAM Boost™ Display assembly includes a SAM Boost™ display, a buzzer (depends on order type), a display power module w/bracket, and an optional panel adapter that fits existing Governor cutouts without

PHONE: (800) 288.1161

[www.akronbrass.com](http://www.akronbrass.com)



panel modifications. The adapter also includes extra holes for offsetting the display in case of interferences with nearby panel components.



Follow the steps below for SAM Boost™ Display installation:

- Unplug and Remove Original Equipment Pressure Governor
  - Leave governor harness installed as it will connect to SAM Boost™ Harness
- Mount SAM Boost™ Display with Adapter Plate
- Attach one of the two bezel labels included depending on the orientation of the display.



- The display UI has a vertical orientation by default but can be changed to horizontal. See password section for details on how to change the UI orientation.
- Connect all Harnesses shown on System Layout Drawing (FSG-PL-01530)

PHONE: (800) 288.1161

[www.akronbrass.com](http://www.akronbrass.com)



- The back of the display has the letter B and C next to the middle two ports
  - Plug in harness labeled port C into C port
  - Plug in harness labeled port B into B port
- Plug in the Display Power Module.

- Plug original governor harness into SAM Boost™ harness



If Buzzer Included in Kit:

- Remove Original Equipment Buzzer
- Install SAM Boost™ Display Buzzer

PHONE: (800) 288.1161

[www.akronbrass.com](http://www.akronbrass.com)

If starting from a new build of the panel, the following figure shows the cutout information required for installing the display.

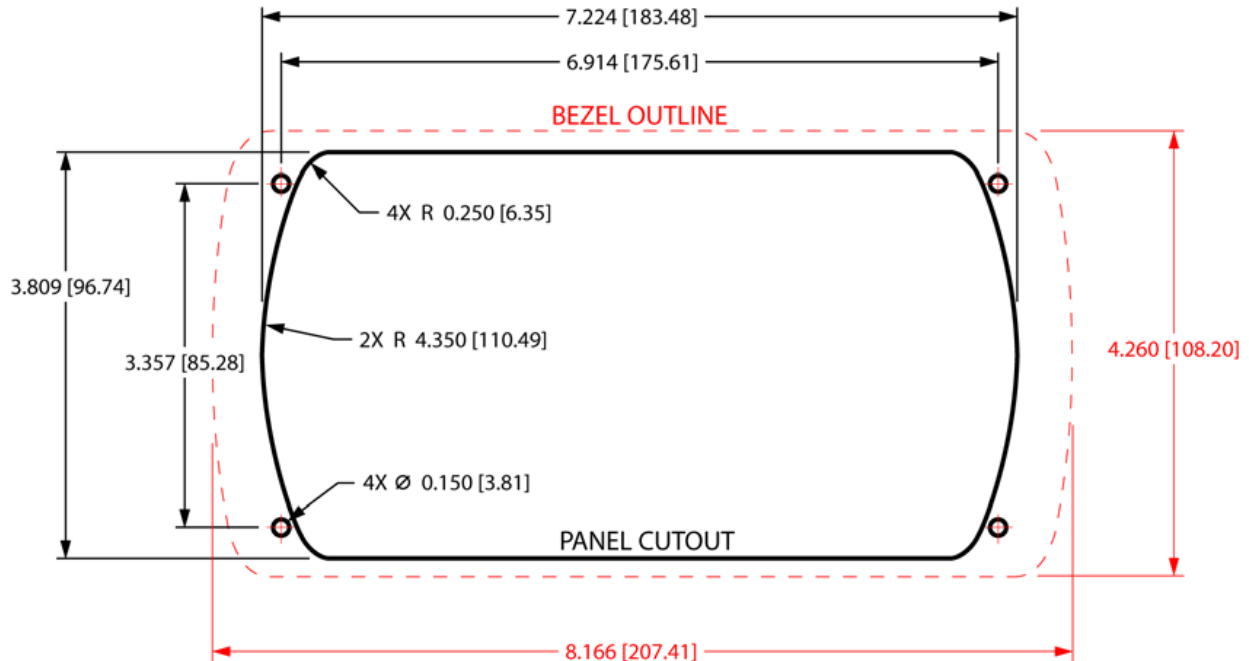

**5.7.2 WARNING LABEL & COVER PLACARD INSTALLATION**

While using the SAM Smart Nozzle, the following warning labels have been included and must be installed for safety concerns while operating the preconnect hoses. Locate and place the label where the Smart Nozzle hoses will be stored and deployed on the truck.



An additional item included in the SAM Boost™ Kit are placards for covering the push-pull control holes left after removing the control components for the two Preconnect Discharge and Tank-to-Pump valves. Place the placard over the exposed cutout holes. For control elements where the placard cannot fully cover the cutouts, please contact Customer Service for alternative solutions.



## NOTICE

Before placing either of labels or placards, make sure the surface of the area is thoroughly cleaned and free of foreign materials to maximize life of the label adhesive.

### 5.8 MATRIX MODULE INSTALLATION

The Matrix Module assembly includes an optional mounting bracket that can be installed to either a 2.5", 3", or 4" side discharge valve of the pump. The assembly should be installed closest to the operator panel and within reach of the CAN Network Hub as its maximum length is 39". Follow the steps below for Matrix module installation:

- Mount Matrix Module assembly to Valve
  - Adapter fits 2.5", 3", or 4" Valves

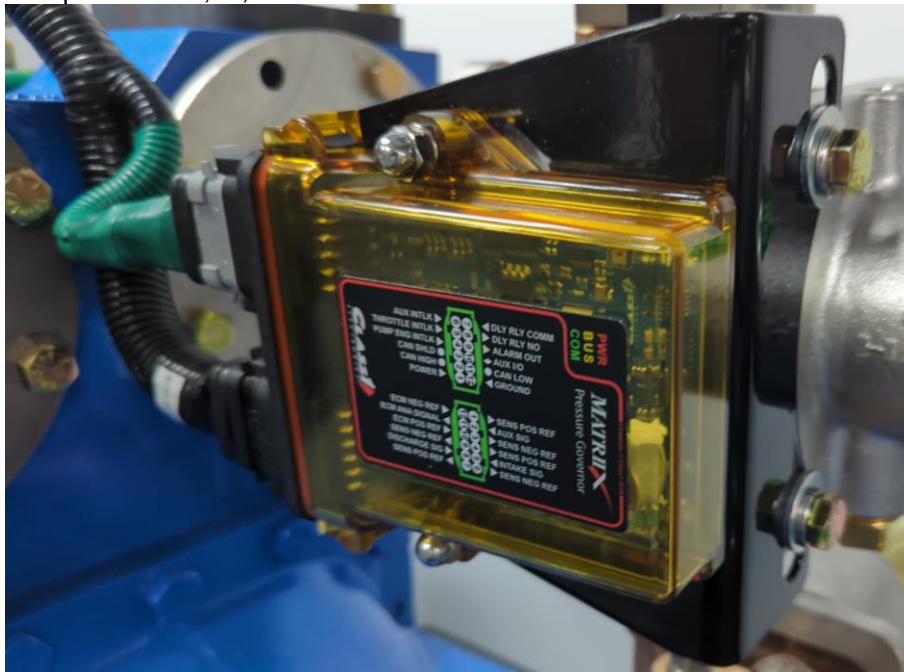

## NOTICE

It is recommended to install the module such that the electric connectors are oriented downward or sideways to avoid water build-up and intrusion.

PHONE: (800) 288.1161

[www.akronbrass.com](http://www.akronbrass.com)

- Connect Matrix Harness as shown on System Layout Drawing (FSG-PL-01530)
  - Connect Grey Matrix module connection
  - Connect Black Matrix module Connection.

### 5.8.1 Pressure Transducer Installation

Included with the kit are calibrated Master Intake and Master Discharge pressure transducers. Locate and replace the original equipment Master pressure transducers with the new ones. Following the steps below:

- Located Original Equipment Master Intake & Discharge Pressure Sensors
  - Note that some systems may not have Master intake transducers
    - If the truck did not originally include a Master Intake pressure transducer, locate a 1/4" NPT port on the suction side of the pump
- Remove Original Equipment Master Intake & Discharge Pressure Sensors
- Install SAM Boost™ pressure transducers

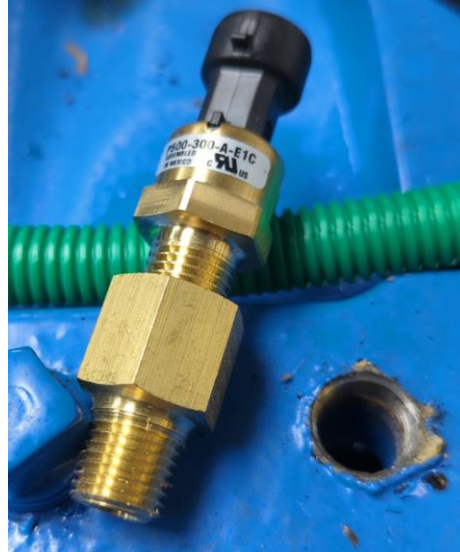

#### NOTICE

It is recommended to install the pressure transducers so that they are oriented between +/- 45 degrees from vertical to ensure proper drainage and avoid the buildup of sediment.

#### NOTICE

It is recommended to torque the sensor at the adapter fitting as overtightening the sensor itself can alter the factory calibration. If recalibration is required follow the instructions in the password section for pressure calibration (08266).

- Connect the SAM Boost™ Harness to the transducers per the System Layout Drawing (FSG-PL-01530).
  - Provide a service loop to the transducers.



## 5.9 WATER TANK COMPONENT INSTALLATION

The SAM Boost™ System includes two assemblies that will require installing into the truck water tank, the Pump Venting Solenoid and SAM Boost™ Tank Assembly.

### 5.9.1 PUMP VENTING SOLENOID INSTALLATION

The Pump Venting Solenoid installation is divided into two assemblies, the solenoid and check valve assembly.

The solenoid assembly will need to be installed on the discharge side of the pump. Follow the steps below:

- Locate a suitable 1/4" NPT port
- Install the assembly with the pencil strainer side inserted into the pump
- Connect the solenoid to the main harness and provide strain relief.

The check valve assembly will need to be installed either on the truck water tank or on the discharge side of the Tank Fill valve (shown below).



- Locate a suitable location for pump vent to discharge into.
- Install the check valve with the arrow pointed away from the direction of flow from the solenoid.
- Route and connect 3/8" push-on hose tubing between the two assemblies.

#### **NOTICE**

When routing the hose tubing, make sure to avoid kinking or bending the tubing. The hose tubing should be routed such that it can drain naturally towards the water tank or Tank Fill valve as to avoid freezing and damaging the tubing.

### 5.9.2 SAM BOOST™ TANK ASSEMBLY INSTALLATION

The SAM Boost™ Tank Assembly will require the following steps for installation:

- Locating and removing the original equipment water tank level transducer.
- Once this is completed, install the new assembly in its original location. The original transducer can be installed into SAM Boost™ Tank Assembly using the fittings provided if it is still being used on the truck separate from the SAM Boost™ System.



#### **NOTICE**

It is recommended to install the water tank level transducer connector oriented between 45° to 90° from the horizontal to allow drainage and avoid sediment build-up.

- Once all components have been installed, connect the SAM Boost™ Harness to the new water tank level transducer per the System Layout Drawing (FSG-PL-01530).
  - Provide a service loop to the harness plugging into the tank level sensor.
- Calibrate tank level using the Tank Level Calibration Password (08265)

## 6. OPERATION

The sections below detail out screen functionality and general SAM Boost™ Operation

### 6.1 SAM BOOST™ SCREEN LAYOUT

There are 3 main operation screens in SAM Boost™ that have following functions:

1. Home Page
  - i. Discharge valve status
  - ii. Tank to pump control and status
  - iii. Engine Information and control.
2. Discharge Valve 1 Page
  - i. Discharge Valve 1 Status
  - ii. Discharge Valve 1 control
  - iii. Nozzle 1 Status
3. Discharge Valve 2 Page
  - i. Discharge Valve 2 Status
  - ii. Discharge Valve 2 control
  - iii. Nozzle 2 Status

#### 6.1.1 Home Page

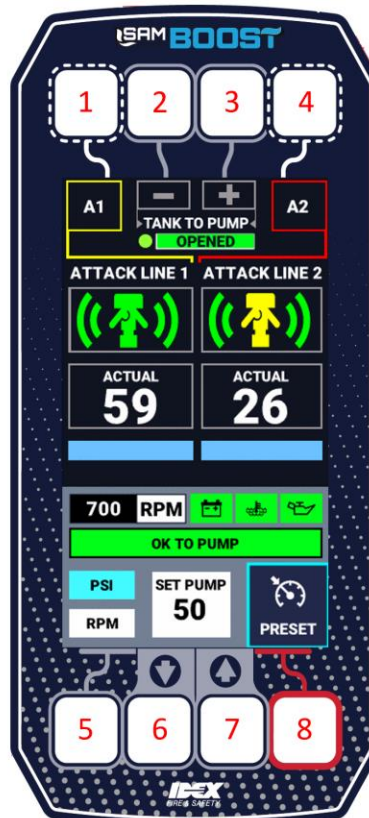

1. Go to Valve 1 Control Page
  - a) Note that Color is customizable
2. Close Tank to Pump
3. Open Tank to Pump
4. Go to Valve 2 Control Page

PHONE: (800) 288.1161

[www.akronbrass.com](http://www.akronbrass.com)

- a) Note that Color is customizable
- 5. Select Governor Mode (PSI or RPM)
  - a) **SAM Nozzle only works in PSI Mode**
- 6. Decrease desired pump pressure
  - a) If RPM mode, then decrease desired RPM
- 7. Increase desired pump pressure
  - a) If RPM mode, then increase desired RPM
- 8. Emergency Idle button
  - a) Preset Button when at idle speed.

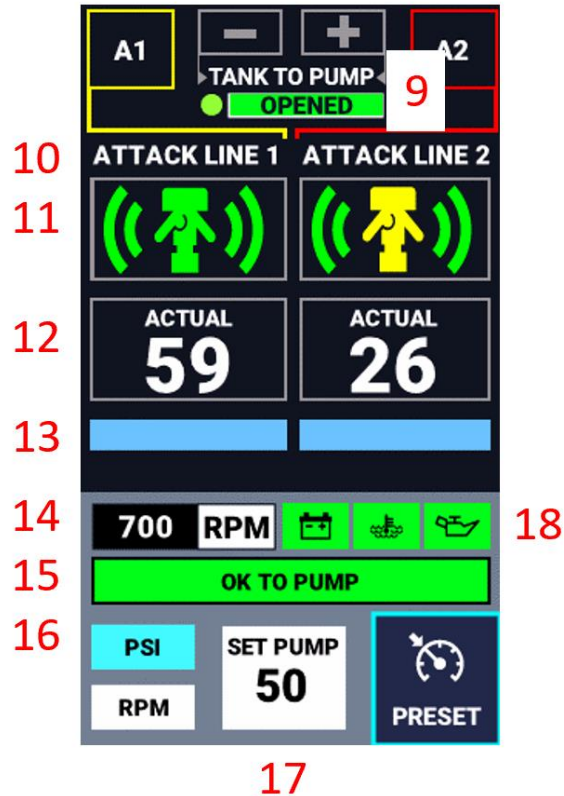

- 9. Tank to pump current position. Bar graph will slide based on valve % open.
- 10. Valve Friendly Name – This is a customizable name from a select list.
- 11. Valve Set Pressure (nozzle active)
  - a. Wi-Fi Bars will change color (RED, YELLOW, & GREEN) based on nozzle signal strength.
  - b. Nozzle icon will change color (RED, YELLOW, & GREEN) based on battery life.



**BATTERY  
CONDITION**  
(30% - 0%)



**WI-FI  
SIGNAL**  
(30% - 0%)



**BATTERY  
CONDITION**  
(70% - 31%)

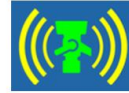

**WI-FI  
SIGNAL**  
(70% - 31%)



**BATTERY  
CONDITION**  
(100% - 71%)



**WI-FI  
SIGNAL**  
(100% - 71%)

12. Valve Actual Pressure

\*Note this is valve pressure and not nozzle pressure

13. Valve Status

- a. Blue = Good
- b. Orange = Manual
- c. Black with low flow text = Low flow mode
- d. Yellow = No Nozzle Control (Loss of signal or no battery life)

14. Current RPM

15. Interlock status (okay or not okay)

16. Mode selected = blue is psi, orange is rpm, white is no mode

17. Set PSI or SET RPM depending on Mode

18. Battery, Coolant, and pressure status.



## 6.1.2 Discharge Valve Page

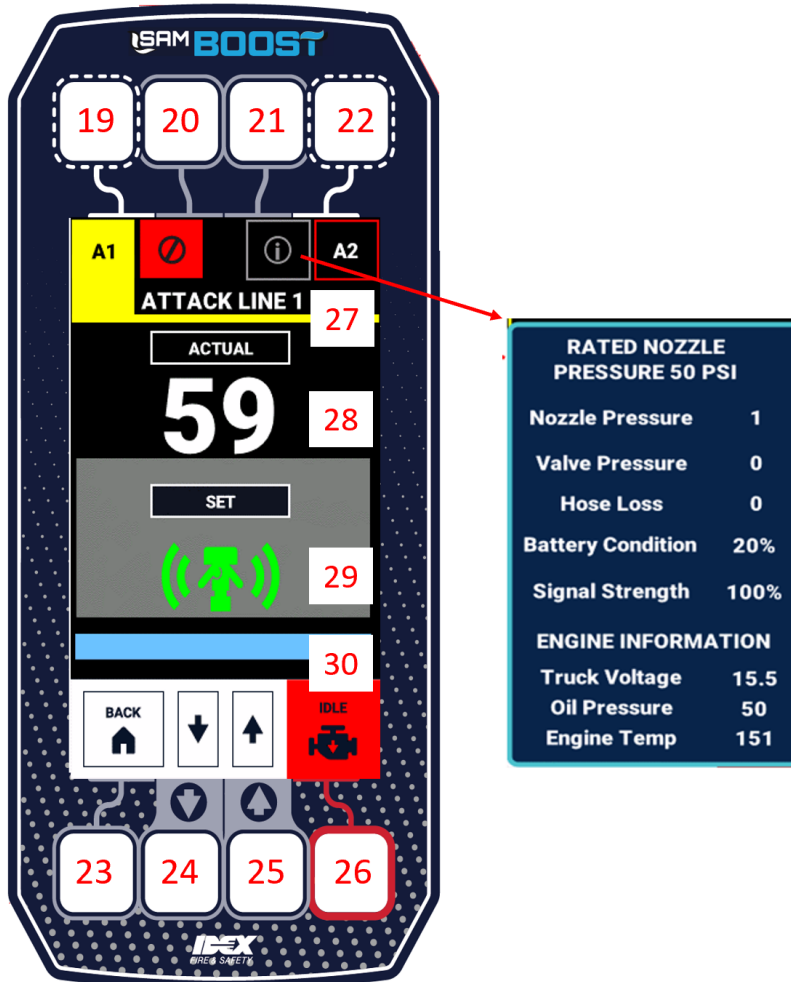

19. Discharge 1 valve control page
  - a. Hold for Discharge 1 Manual Mode Switch
20. Preset/Close Button
  - a. Close valve if open
  - b. Open to Preset psi if closed.
21. Nozzle info button—Hold to see:
  - a. Nozzle Pressure
  - b. Valve Pressure
  - c. Hose Loss
  - d. Signal Strength
  - e. Battery Strength.
  - f. Engine Information
    - Truck Voltage
    - Oil Pressure
    - Engine Temp
22. Discharge Valve 2 control page.
  - a. Hold for Discharge 1 Manual Mode Switch
23. Back to home page button.
24. Decrease valve set pressure

PHONE: (800) 288.1161

[www.akronbrass.com](http://www.akronbrass.com)

25. Increase valve set pressure
26. Emergency idle
27. Valve friendly name
28. Actual Valve Pressure
29. Valve Set Pressure (nozzle active).
30. Flow status

## 6.2 SAM BOOST™ Standard Operation

### 6.2.1 Pump Engagement

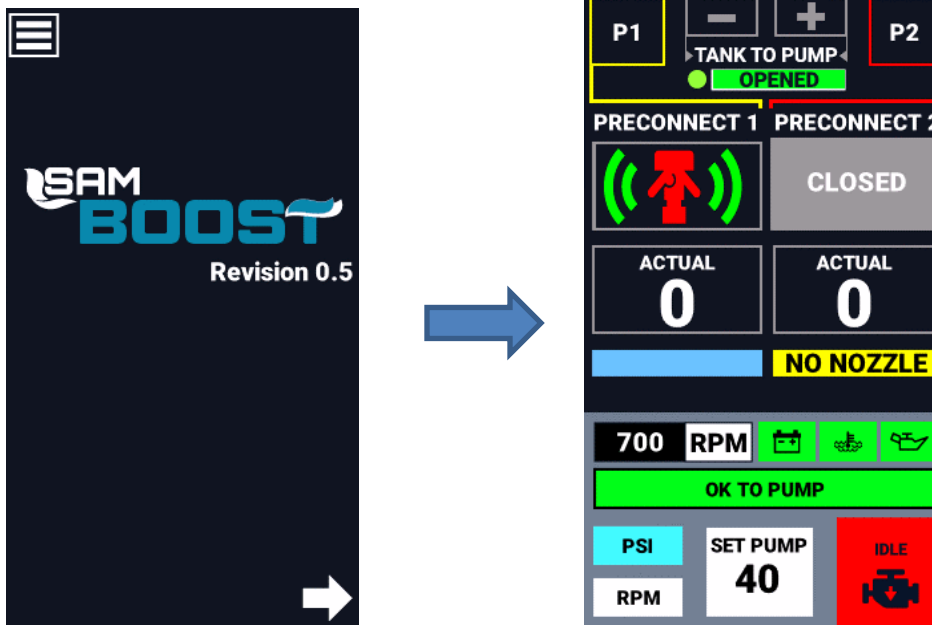

Engaging the pump will cause the start of the following sequence:

1. Display will switch from splash screen to home page.
2. The Tank-to-pump will automatically open
3. The system is force to PSI governor mode
4. The pump recirculation valve will open.
5. The Smart Nozzle will begin showing its status and is ready to be called.

### 6.2.2 Smart Nozzle Status Indicators

#### NOTICE

Tank level indication on the SAM™ SMART NOZZLE are visible only when the pump is engaged (pump mode) and the nozzle is active.

When the Smart Nozzle is available to be activated, it will show the tank status. The SAM™ SMART NOZZLE LED display provides information on the amount of water in the tank on the truck. This is done via wireless communication between the SAM™ SMART NOZZLE and the SAM BOOST™ truck. Below are the colors and levels for various tank conditions. Green is a full tank (greater than 75% full), yellow is partially filled tank (75%-25% full), and red is a low tank (Less than 25% full).

PHONE: (800) 288.1161

[www.akronbrass.com](http://www.akronbrass.com)

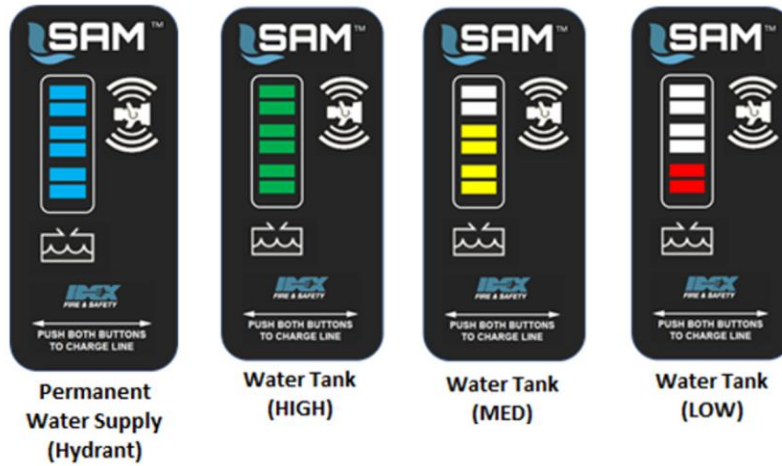

When a hydrant is established at the SAM BOOST™™ truck, the SAM™ SMART NOZZLE will automatically switch to a full blue display to indicate this condition.

### 6.2.2.1 Smart Nozzle Error Status



The SAM™ SMART NOZZLE uses a wireless communication method to remain in contact with the SAM BOOST™™ system on the truck. If for any reason that communication is lost while in pump mode, the LED display on the SAM™ SMART NOZZLE is designed to turn off (go dark) as shown below. This does not affect the general operation of the nozzle, which will still function as a normal handline nozzle without a SAM™ SMART NOZZLE system. The Boost™ system on the truck is designed to account for this situation and will adjust as needed to maintain water flow and nozzle pressure.



If the SAM™ SMART NOZZLE is able to remain in contact with the SAM Boost™ system on the truck, but an issue occurs at the truck before attempting to charge the hose, the LED display on the SAM™ SMART

PHONE: (800) 288.1161

[www.akronbrass.com](http://www.akronbrass.com)

NOZZLE will instead slowly blink red at the lower LED pair as shown below for 1 second at a 4 second interval. Any attempts to charge the line will not occur until the issue is resolved.

Note that this error state will occur if:

- System is not in PSI mode
- Operator has manually overridden system

### 6.2.3 CHARGING THE HOSE FROM THE SAM™ SMART NOZZLE

#### NOTICE

A paired valve with the SAM™ SMART NOZZLE can only be activated in pump mode.

#### ⚠ WARNING

Do not activate a paired valve while hose is still packed in the hose bed, cross-lay or speed-lay. Doing so may result in damage to the hose and surrounding structure of the truck and may cause bodily injury due to rapid hose expansion and movement

#### ⚠ WARNING

Do not switch SAM™ SMART NOZZLEs between discharges after the pairing process. Doing so can result in the opening of discharges other than the discharge connected to the paired SAM™ SMART NOZZLE which may cause bodily injury.

#### ⚠ WARNING

Charging the nozzle, may increase the engine rpm and system pressure. This may increase pressure on all discharge lines.

The Smart Nozzle can only be charged via the two function buttons when the system meets the following conditions:

1. Pump Must be in PSI mode
2. The corresponding discharge valve must be closed.
3. The corresponding discharge valve must not be in manual mode.
4. The operator has not manually intervened by manually changing set pressure or manually decreasing pump pressure.

When ready to activate a paired SAM™ SMART NOZZLE and valve, **SIMULTANEOUSLY** press and hold the two function buttons located on either side of the SAM™ SMART NOZZLE module for a minimum time of 2 seconds. Release after the 2 second period. The LED display on the SAM™ SMART NOZZLE will illuminate in a yellow wig-wag sequence as shown below indicating the signal to open the valve has occurred. The wig-wag sequence will continue for approximately four (4) seconds and will then switch to the tank level display. The valve at the truck will commence to open and provide water to the SAM™ SMART NOZZLE.

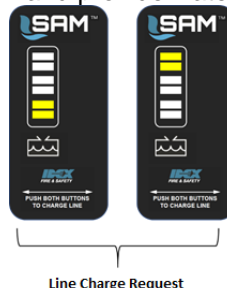

Upon a successful Smart Nozzle charge:

1. The valve will open to the desired set pressure.
  - a) The valve will automatically adjust position to maintain set pressure.
  - b) The set pressure will automatically adjust to maintain nozzle pressure (up to 20 psi)
2. The Master Pump Pressure will increase to valve set pressure plus 10 psi
3. The Nozzle Icon will appear on the screen.

PHONE: (800) 288.1161

[www.akronbrass.com](http://www.akronbrass.com)

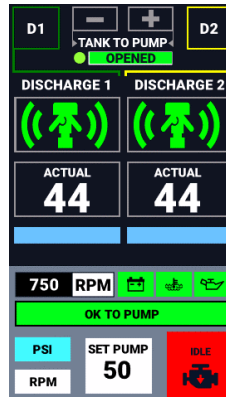

### 6.2.4 Hydrant/Draft Changeover

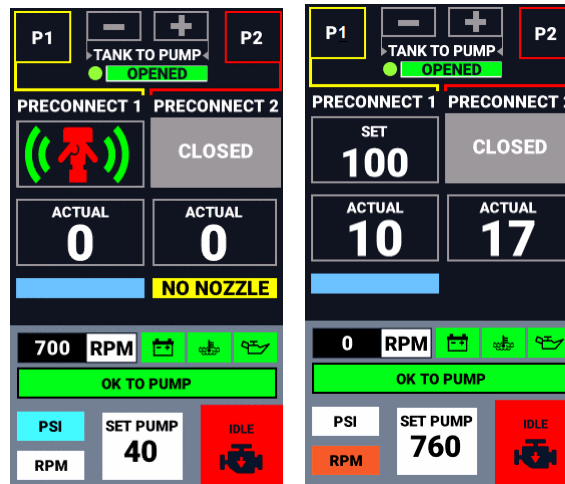

Follow your jurisdiction's SOP for hydrant or draft changeover

1. Put pump into desired Governor mode
  - a. Some SOPs require the need to switch to RPM mode during changeover events. While in RPM mode, the Smart Nozzle will lose control since the system is governed by RPM instead of pressure. Returning to PSI Mode will restore Smart Nozzle control
2. Establish the water source following your jurisdiction's SOP
  - a. Use the + and – buttons at the top of the screen to control tank to pump valve and close when appropriate.



## 6.2.5 SAM Smart Nozzle Override

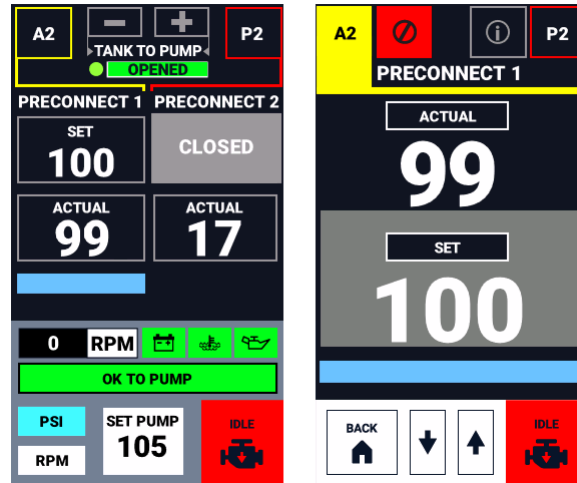

If the user interacts with the discharge valve on the screen or there is an issue with the nozzle then the user will enter the Nozzle Override state as shown to the above. In this state, the nozzle icon will disappear and be replaced with the desired valve set pressure. The nozzle auto control will be turned off in this state, but regular SAM control is still available. This state can be achieved in the following ways:

- Opening valve with preset button on the screen
- Loss of signal with nozzle
- Manually Change valve set pressure with the up/down arrows on the control page.
- Decreasing Master Discharge Pressure.
- Going into RPM mode
- Hitting the idle button

## 6.2.6 Discharge Valve Manual Override

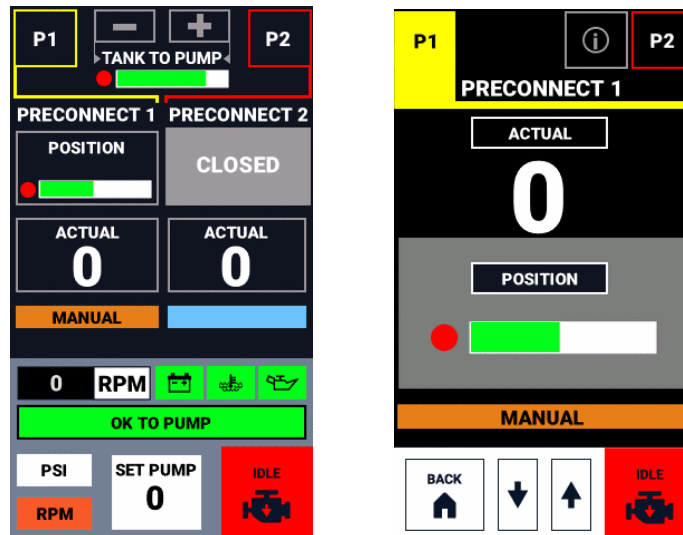

If the user holds the manual mode button on the valve control page, then the valve will enter manual override mode. In this state, there is no automatic pressure regulation. The valve will stay stationary at the position it is in. The screen pages will show the valves desired set position. The valve desired position can be adjusted using the up/down arrows on the valve control page. Holding the manual mode button again will put the valve back into a normal state. Closing the valve and power cycling the system will also return the valve to a normal state

PHONE: (800) 288.1161

[www.akronbrass.com](http://www.akronbrass.com)

## 6.2.7 System Shut Down



When you are ready to shut the system down perform the following:

1. Close all discharge valves by going to the valve page and hitting the red close button (shown above)
2. Idle the truck by hitting the idle button.
3. Take the Truck out of pump gear
  - Note that this will automatically close the tank to pump

### 6.3 System Operational Warnings

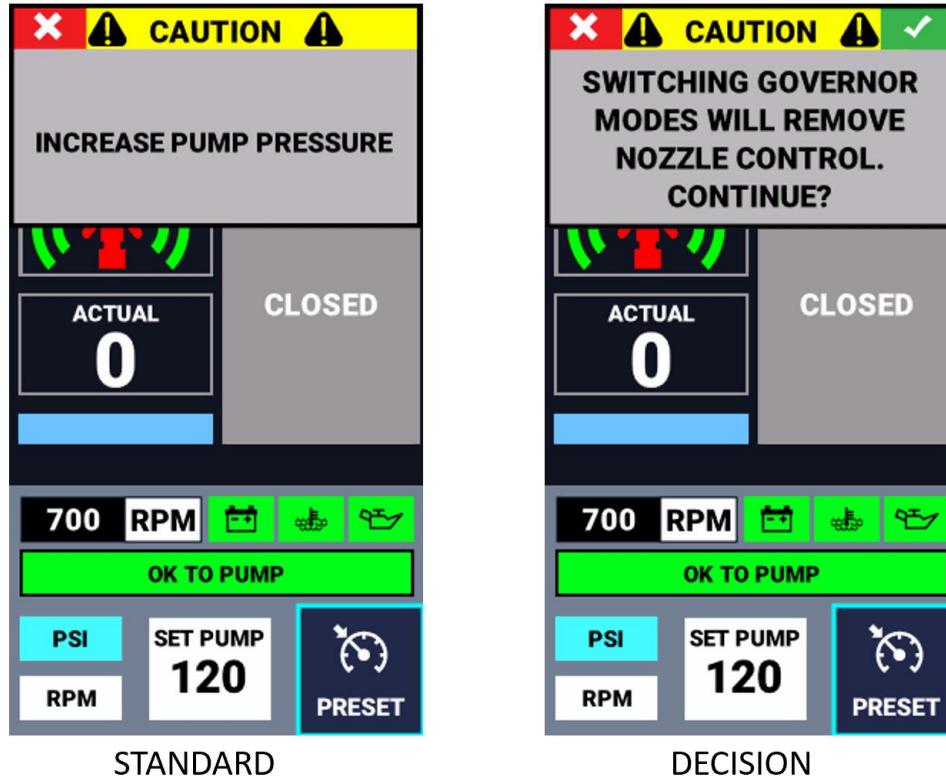

There are two types of warnings on the SAM Boost™ System. Standard warnings and decision warnings. Standard warnings alert the user of a problem. Decision warnings require the user to select yes or no to the prompt on the warning.

#### 6.3.1 Standard warnings

STANDARD WARNING	REASON
LOW TANK WATER	Tank is under 25%
Cavitation Warning	RPM increasing but PSI decreasing
Possible Cavitation	RPM increasing but PSI staying the same
Max Valve Pressure	Desired pressure at max value
Closing Valve	Valve is in process of closing
Low Voltage	Voltage under NFPA minimum

PHONE: (800) 288.1161

[www.akronbrass.com](http://www.akronbrass.com)



## SAM BOOST™ WITH SMART NOZZLE N<sub>2</sub>P INSTALLATION, OPERATING, & MAINTENANCE MANUAL

Check Engine	Temp/Pressure Error from Engine
Increase Pump Pressure	Master Pressure not high enough to sustain SAM enabled Valve
Pressure Falling	Discharge pressure under 30 psi
Check Water Supply	Discharge pressure at 0 psi
VALVE 1 COMM LOST	CAN or Power lost at discharge valve
VALVE 2 COMM LOST	CAN or Power lost at discharge valve
RADIO COMM LOST	CAN or Power lost at module
T2P COMM LOST	CAN or Power lost at T2P valve
Engine Comm Lost	CAN or Power lost at module

### 6.3.2 Decision warnings

WARNING	REASON	RESULT OF ACCEPTING
Low Nozzle Pressure. Continue Pressure Increase?	Nozzle Pressure under desired pressure due to kink or additional hose lose.	Valve pressure will increase up to an additional 20 psi
Switching Governor Modes Will Remove Nozzle Control. Continue?	User trying to enter RPM Mode	Nozzle will no longer auto control pressure and user will enter RPM mode.
Decrease Governor Pressure will remove Nozzle Control	User trying to manually decrease Governor pressure	Nozzle will no longer auto control pressure and user can decrease pump pressure.
Switching modes will Remove Nozzle control. Continue?	User trying to manually set valve pressure.	Nozzle will no longer auto control pressure and user can change valve pressure.
Enable auto pressure control?	User trying to enter PSI mode	Nozzle May regain auto control and pump pressure will auto regulate.

#### 6.3.2.1 LOW NOZZLE PRESSURE Warning



Do not continue increasing pressure until confirming there are no issues with the hose. Ignoring to do so will result in damage to the hose and surrounding structure of the truck and may cause bodily injury due to rapid hose expansion and movement.

PHONE: (800) 288.1161

[www.akronbrass.com](http://www.akronbrass.com)



## SAM BOOST™ WITH SMART NOZZLE N<sub>2</sub>P INSTALLATION, OPERATING, & MAINTENANCE MANUAL

The SAM™ SMART NOZZLE in operation continuously compares the Nozzle Pressure against the Valve Pressure difference represented by Hose Loss in the Nozzle Information page. If the Hose Loss difference is greater than the max limit while the hose is charged, the UV450 display will show the following message of whether to continue increasing to the rated pressure at the nozzle. This feature's purpose is to warn the operator if there are issues with the charged hose such as kinking, pressure loss, etc. This keeps the automatic pressure increase below the pressure control limits in NFPA.

### 6.3.2.2 SWITCHING GOVERNOR MODES Warning



Automatic pressure regulation will be removed if accepting this warning. Uncontrolled pressure rises or loss may cause injury or bodily harm to user.

Accepting this warning puts the governor into RPM mode. The SAM™ SMART NOZZLE only automatically controls the nozzle pressure in PSI mode.

### 6.3.2.3 DECREASE GOVERNOR PRESSURE Warning



Automatic nozzle pressure regulation will be removed if accepting this warning. Uncontrolled pressure rises or loss may cause injury or bodily harm to user.



Lowering the pump pressure under the desired line pressure will cause pressure loss on the discharge line.

### 6.3.2.4 SWITCHING MODES Warning



Automatic pressure regulation will be removed if accepting this warning. Uncontrolled pressure rises or loss may cause injury or bodily harm to user.

Accepting this warning puts the valve into standard SAM mode and removes SAM™ SMART NOZZLE control. The operator must manually control line pressure to maintain nozzle pressure for the rest of the pump cycle.

### 6.3.2.5 ENABLE AUTO PRESSURE CONTROL Warning



Automatic pressure regulation will return after accepting this warning. This may increase the engine rpm and system pressure which may increase pressure on all discharge lines.

Accepting this warning puts the system back into PSI mode what SAM BOOST™ pressure regulation will return.

## 6.4 CHECKING BATTERY CHARGE LEVEL & WI-FI STRENGTH

### NOTICE

The SAM™ SMART NOZZLE information can only be displayed when the nozzle is awake. Press any of the two function buttons located on either side of the SAM™ SMART NOZZLE module until the LED display illuminates to wake up the nozzle.

PHONE: (800) 288.1161

[www.akronbrass.com](http://www.akronbrass.com)





## SAM BOOST™ WITH SMART NOZZLE N<sub>2</sub>P INSTALLATION, OPERATING, & MAINTENANCE MANUAL

Follow the steps below to check the nozzle battery life and signal strength:

1. Hit the arrow button on the bottom right of the splash screen and go into the home page
  - a. If in pump mode, then user will skip step 1.



2. Select Valve 1 or Valve 2 in the top left or top right of the home page to check Nozzle 1 or Nozzle 2

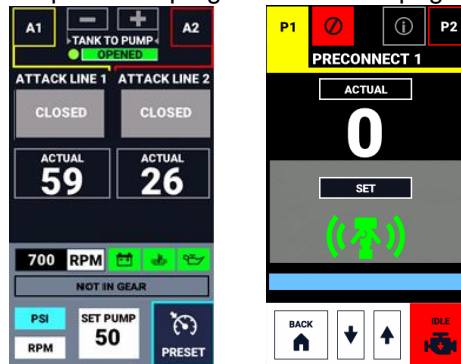

3. Pressing the info icon will open a new window, displaying the current battery life & Wi-Fi signal strength of each paired nozzle.
  - a. Wake up nozzle if nozzle is not awake
  - b. Note that nozzle will go back to sleep after 30s if pump not in gear

RATED NOZZLE PRESSURE 50 PSI	
Nozzle Pressure	24
Valve Pressure	43
Hose Loss	19
Battery Condition	90%
Signal Strength	100%
ENGINE INFORMATION	
Truck Voltage	13.3
Oil Pressure	24
Engine Temp	181

PHONE: (800) 288.1161

[www.akronbrass.com](http://www.akronbrass.com)

## 7. PASSWORDS AND CALIBRATIONS

### Password listings

UV450	Function
00311	Governor Settings Page
00401	Smart Nozzle Settings Page
08265	Water Calibration Page
08266	Valve Position Calibration Page
08267	Valve Pressure Calibration Page
10600	Smart Nozzle Pairing Page
10610	Smart Nozzle Calibration Page
06565	Voltage Warning Settings
14000	Orientation Toggle (Vertical or Horizontal)

### 7.1 Entering Passwords

On power up, you will see the SAM BOOST™ splash screen (Center image) without the pump engaged. The splash screen will give access to the pass code screen (Left image) by pressing the upper left button or the main valve status screen (Right image) by pressing the lower right button below the right arrow icon.

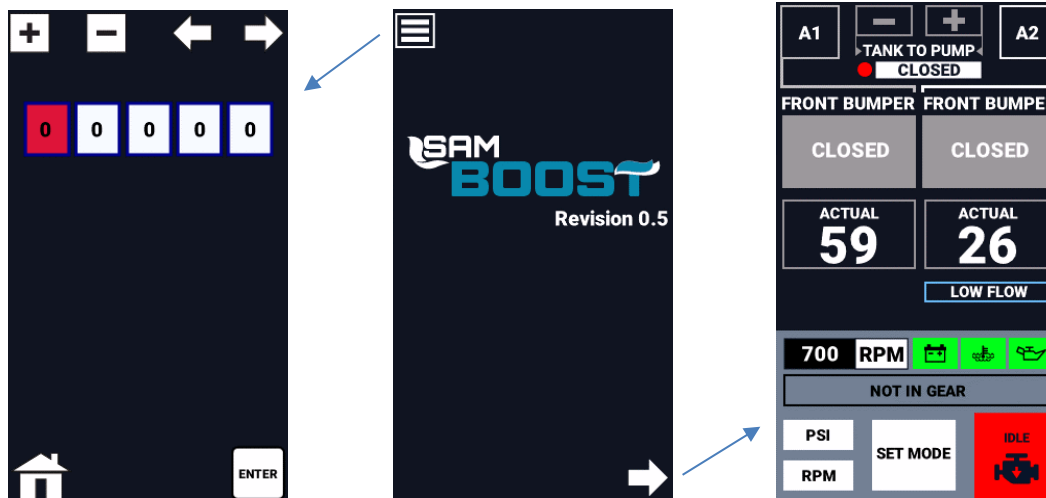

Without the pump engaged, the operator can program valve presets, nozzle calibrations, line colors, line identifications, and other settings using the passwords in the listing table provided above.

Enter a password by increasing or decreasing the number in the highlighted box with the + and – buttons at top. Move to the next box by using the right and left arrows at the top of the screen. Select enter at the bottom right when ready.

PHONE: (800) 288.1161

[www.akronbrass.com](http://www.akronbrass.com)

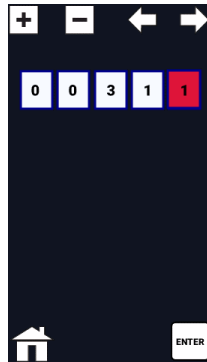

## 7.2 Governor settings (Password 00311)

The Settings Page (00311) will give the user the option to set up the parameters of the listing below.

	Name	Current Value	New Value
Page 1	unit of measure	U.S.	
	Rounding	None	
	Preset Pressure 1	100	
	Preset RPM1	2000	
	First Mode	Pressure	
	Pressure Scale	300	
	Pressure Sensitivity	0	
Page 2	Governor Gain	0	
	Pressure Averaging	None	
	Engine Type	CFPG	
	Engine Idle Speed	750	
	Engine Max Speed	0	
	Interlock Mode	Normal	
	Zero Sensor		
Page 3	Engine Address	0	
	Governor Address	0	
	Transmit Control Message at Idle	No	
	Discharge High Calibration		
	Intake High Calibration		
	HP High Calibration		
	Baud Rate Selected	500K	
	Engine Driveline Type	Split-Shaft	
	PrePrime Enabled	Disabled	
	PSI CHANGE	5	
	Pressure Lag		
	Analog Idle Volts	32	
	Assert Analog Idle Volts When	Mode Selected	
Analog RPM Gain	15		

PHONE: (800) 288.1161

[www.akronbrass.com](http://www.akronbrass.com)

### 7.2.1 Engine Settings

The system is defaulted to a Cummins Engine (CFPG) that has an Engine Baud rate of 500K. See the sections below for information on how to change the standard engine settings.

#### 7.2.1.1 Changing the Display's Baud Rate

1. Enter Password (00311)
2. Hit the down arrow until "BAUD RATE SELECTED" is highlighted yellow.
3. Hit the Right arrow until desired Baud Rate is shown.
4. Hit Enter.
5. Power cycle Truck.

#### 7.2.1.2 Changing the Engine Control type

1. Enter Password (00311)
2. Hit the down arrow until "Engine Type" is highlighted yellow.
3. Hit the Right arrow until desired engine control type is shown.
4. Hit Enter.
5. Power cycle Truck.

#### 7.2.1.3 Ford Engine Control Settings

If installing SAM BOOST™ onto a Ford Truck (with OBDII communication), then enter the following settings on the 00311 Password page.

<b>FORD F-550 DEFAULT SETTINGS</b>	
<b>DESCRIPTION</b>	<b>SETTING</b>
ENGINE TYPE	FORD ANALOG*
ENGINE IDLE SPEED	850**
ANALOG IDLE VOLTS	9**
ANALOG RPM GAIN	12
BAUD RATE	500K

\*If truck has gateway module underneath dash then it will need to be set as a ANALOG engine type. Gateway module shown below:

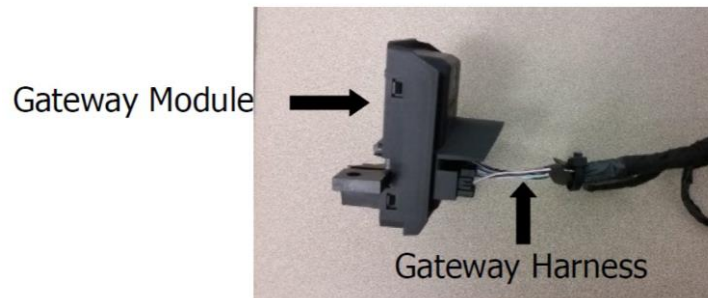

\*\*User needs to verify that when the truck is in gear and at idle then the Master Pressure of the truck is above 30 psi. If not, then user needs to increase these values.



## SAM BOOST™ WITH SMART NOZZLE N<sub>2</sub>P INSTALLATION, OPERATING, & MAINTENANCE MANUAL

### 7.2.1.4 Analog Engine Control Settings

If installing SAM BOOST™ onto an Analog controlled engine, then enter the following settings on the 00311 Password page.

ANALOG DEFAULT SETTINGS	
DESCRIPTION	SETTING
ENGINE TYPE	ANALOG
ENGINE IDLE SPEED	750*
ANALOG IDLE VOLTS	32*
ANALOG RPM GAIN	15**
BAUD RATE	Depends on Engine Make and Model

\*User needs to verify that when the truck is in gear and at idle then the Master Pressure of the truck is above 30 psi. If not, then user needs to increase these values.

\*\*If engine is too fast or slow to respond to a pressure request then this value will need modified. Increasing this value will slow down the engine response. Decreasing this value will speed up the engine response.

### 7.3 SAM Smart Nozzle Settings (00401)

Smart Nozzle settings page gives the user custom settings for line ID, line colors, nozzle pressure presets and valve prefixes. Use the up and down arrows to select the category and the right arrow to change the values. Select enter when preferences are complete. The settings will take place at the next power cycle.

NAME	Current Value	New Value
Valve 1 Name	JUMP LINE	JUMP LINE
Valve 1 Color	YELLOW	YELLOW
Valve 1 Preset	100	100
Valve 1 Nozzle Pressure	50	70
Valve 1 Prefix	A2	A2
Valve 2 Name	FRONT BUMPER	FRONT BUMPER
Valve 2 Color	RED	RED
Valve 2 Preset	100	100
Valve 2 Nozzle Pressure	100	70

The listed names, prefixes, and color options available below apply for both valves. The valve 1 & 2 nozzle pressure values are programmable per user preference.

Names	Colors	Prefixes
Attack Line 1	Orange	A1
Attack Line 2	Red	A2
Attack Line 3	Yellow	A3
Attack Line 4	White	A4
Attack Line 5	Blue	A5

PHONE: (800) 288.1161

[www.akronbrass.com](http://www.akronbrass.com)



Preconnect 1	Black	P1
Preconnect 2	Green	P2
Preconnect 3	Silver	P3
Preconnect 4	Purple	P4
Preconnect 5		P5
Crosslay 1		C1
Crosslay 2		C2
Crosslay 3		C3
Crosslay 4		C4
Crosslay 5		C5
Jump Line		JL
Front Bumper		FB
Left Rear		LR
Right Rear		RR
Discharge 1		D1
Discharge 2		D2
Discharge 3		D3
Discharge 4		D4
Discharge 5		D5
Trash Line		TL
MattyDale		M
Speedlay		S

The valve preset pressure can also be adjusted by the user on this page.

#### 7.4 Water Calibration Page (Password 08265)

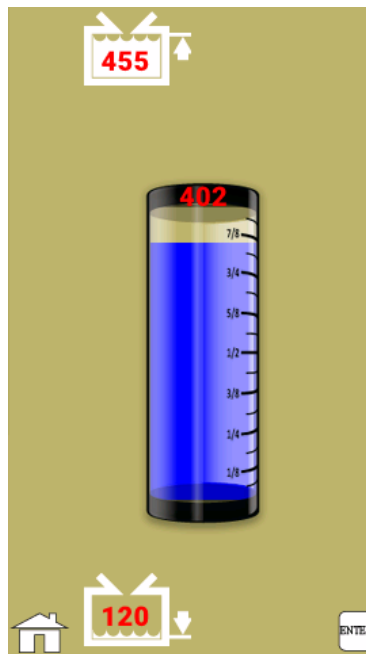

1. Fill the tank.
2. Set the upper level using the button above the tank fill icon (**455 in picture above**).
3. Drain the tank,
4. Set the lower level using the button below the tank empty icon (**120 in picture above**).
5. Then press the button below the enter icon to save settings.
6. Use the button below the home icon to save changes and return to the main menu.

PHONE: (800) 288.1161

[www.akronbrass.com](http://www.akronbrass.com)

**7.5 Valve Position Calibration Page (Password 08266)**

A position calibration is required if a valve actuator has been rotated or adjusted. Follow the steps below to perform a calibration:

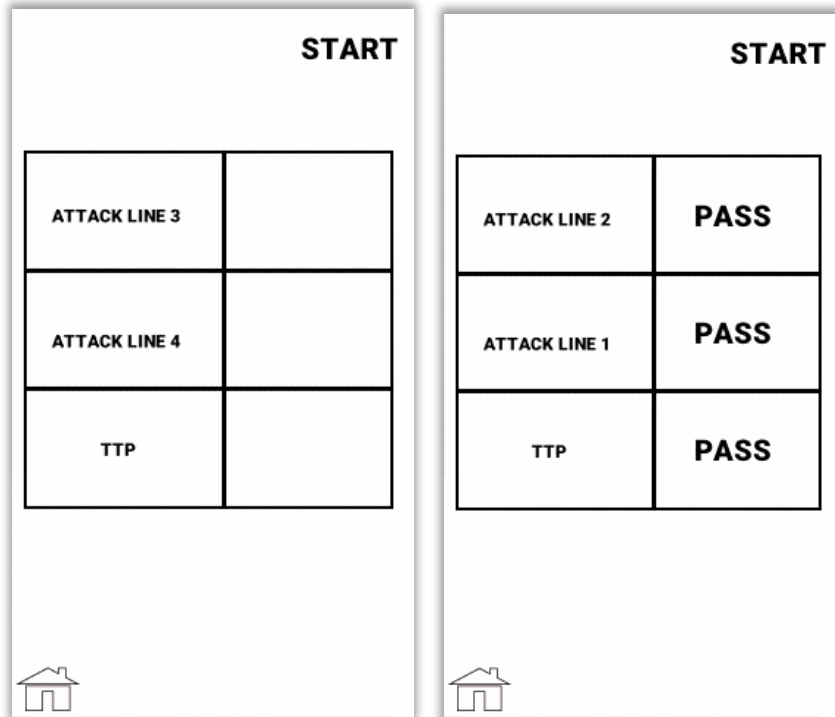

1. The valve position calibration page will automatically run ALL the valves through a position calibration when hitting the top right **start** button.
2. When "PASS" appears, this indicates a successful calibration.
  - a. If position calibration failure, verify truck has proper voltage.
3. A power cycle is required after running

**7.6 Valve Pressure Calibration Page (Password 08265)**

NOTE: Valves arrive calibrated from factory. Calibration may be required annually.

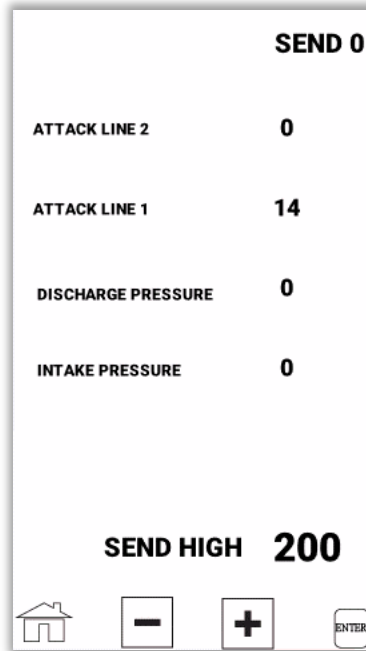

1. Prior to entering password open and cap discharge valves to be calibrated.
2. Enter password **08267** to access above screen.
3. With no pressure on the lines, hit top right button SEND 0
  - a. Note that pressures will not properly update on screen until both zero and high calibration are completed.
4. Increase pump pressure to a known high pressure (200 psi is recommended)
  - a. Pressure value to send can be adjusted with the +/- buttons on the screen
5. Hit the bottom right ENTER button to send high pressure calibration point
6. Release valve pressure.
7. Power cycle

### 7.7 SAM Smart Nozzle Pairing (Password 10600)

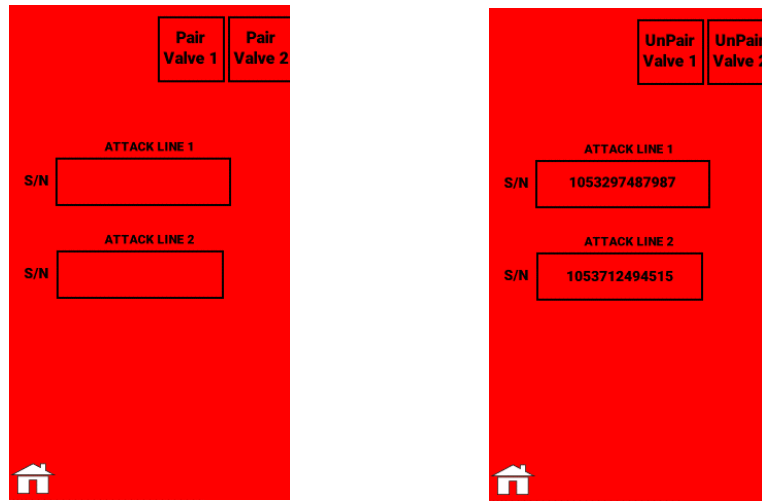

Follow the steps below to pair a nozzle to the system:

1. Press and hold both right and left buttons on the nozzle until the green LEDs flash alternately forward then rearward. (sending radio signal to connect)
2. Observe the green LEDs until the forward and middle LED flash at the same rate. This indicates the connection between the nozzle and 6037 radio module.
3. The nozzles will display the serial number below both empty boxes in the lower open area of screen when SAM Boost™ recognizes the nozzle to pair with.
4. Press the desired 'Pair' button in the top right corner to complete the process. The S/N will appear in the corresponding attack line box when paired. (Two nozzles paired in upper right image)

To unpair a nozzle, press 'Unpair' in the upper right corner button that corresponds to the desired valve line and reset nozzle to factory default mode buy using steps 1 through 4 above.

### 7.8 SAM Smart Nozzle Flow Calibration (Password 10610)



Nozzle Preset Calibration will open discharge valve associated with nozzle and automatically increase line pressure. Calibration must be performed with two people

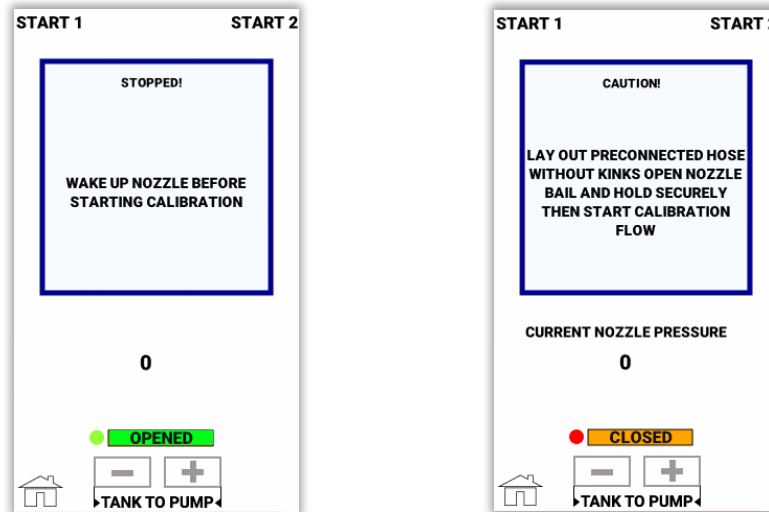

1. Engage Pump while inside Calibration Screen
  - a. SAM Boost™ will default the water source from the internal tank. The nozzles will require a large amount of water to calibrate and is recommended to use draft or hydrant intakes during calibrations. Shut off the tank to pump by pressing the – button to close valve.
2. Wake up Nozzle by Pressing 1 Button
3. Follow Instructions on Display
4. Press START 1 or START 2 to Calibrate Nozzle 1 or 2
5. Valve will open and line pressure will automatically increase until nozzle meets desired pressure message
  - a. Verify that Nozzle Bail is Fully Open when calibrating
6. The calibration process will automatically stop & close line when nozzle pressure is reached
7. Power cycle after completing calibration.





**SAM BOOST™ WITH SMART NOZZLE N<sub>2</sub>P  
INSTALLATION, OPERATING, & MAINTENANCE MANUAL**

**8. FINAL COMMISSIONING CHECKLIST**

Perform the following to verify installation was successful

PASS	CRITERIA	Section Number
<input type="checkbox"/>	Verify Display shows SAM Boost™ Splash screen while Pump in Road Mode & Transmission in Drive Gear with Two People for Safety	6.2.1
<input type="checkbox"/>	Operate Preconnect Valves from Display - Full Open and Full Close (Not required to be in Pump Gear)	6.2.6
<input type="checkbox"/>	Operate Tank-to-Pump Valve from Display - Full Open and Full Close (Not required to be in Pump Gear)	6.2.4
<input type="checkbox"/>	Put into Pump Gear and verify no Warnings appear	6.2.1
<input type="checkbox"/>	Increase and Decrease Engine RPM with the Display (If unable to do so, verify Governor Settings [Password: <b>00311</b> ])	6.1.1
<input type="checkbox"/>	Verify Emergency Idle functions with the Display Press Mode button to revert to PSI Mode	6.1.1
<input type="checkbox"/>	While in PSI Mode, Increase Set Pressure to 100 PSI (or value that increases Engine RPM.) Verify that Pump Set Pressure on Display matches Master Discharge Gauge Pressure	6.1.1
<input type="checkbox"/>	Operate Nozzles to Open the Paired Preconnect Valves	6.2.3
<input type="checkbox"/>	With Two People for Safety, Validate Nozzle Calibration is correct by having one person hold the bail Full Open & the other person at the display checking Actual Pressure equals Rated Pressure with Full Hose Length by pressing the Info Button on valve page	6.1.2
<input type="checkbox"/>	Validate Nozzle Signal Strength is reading appropriately. This can be checked by pressing the info button on the valve page	6.1.2
<input type="checkbox"/>	Validate Truck voltage is reading appropriately. This can be checked by pressing the info button on the valve page (If incorrect, adjust on <b>06565</b> password page)	6.1.2
<input type="checkbox"/>	Drain tank while in Tank Mode and trip low tank warning audio & visual. Warning should trip at ¼ tank level (Validate buzzer operation and tank calibration)	6.3.1
<input type="checkbox"/>	Apply hydrant pressure, close tank-to-pump, and validate that nozzle changes to a blue color	6.2.2
<input type="checkbox"/>	Check Engine Oil Pressure & Temperature	6.1.2

PHONE: (800) 288.1161

[www.akronbrass.com](http://www.akronbrass.com)



## SAM BOOST™ WITH SMART NOZZLE N<sub>2</sub>P INSTALLATION, OPERATING, & MAINTENANCE MANUAL

### 9. MAINTENANCE

Device	Action	Cadence
Batteries	Charge Batteries	After Every Use or monthly if not used
Batteries	Check Battery Life	Weekly
Valve	Exercise Valve	Weekly
Valve	Pressure Calibration	Annually
Valve	Clean out	As Needed
Pump Vent Solenoid.	Check Pump Vent Solenoid Strainer	Bi-Annually
Master Pressure Transducers	Pressure calibration	Annually
Master Pressure Transducers	Clean out	As Needed
Tank level sensor	Tank Level Calibration	As needed
Tank level sensor	Clean out	As Needed

#### 9.1 Nozzle and Nozzle Tip Maintenance

Please review Akron Brass documentation for full parts and maintenance manual

#### NOTICE

There are no user-serviceable parts inside the SAM™ Smart Nozzle. Do not open the nozzle assembly other than to replace batteries. Warranty is void for any nozzle that has been dismantled. Contact factory for technical support.

#### 9.2 Battery Maintenance

Action	Cadence
Charge Batteries	After Every Use or monthly if not used
Check Battery Life	Weekly

##### 9.2.1 CHARGING BATTERIES

Lithium-ion batteries do not have a charge memory, so deep discharging is not required. It is better to use partial discharge cycles via normal use of the SAM™ SMART NOZZLE. It is recommended, however, to log the amount of times the batteries are charged for reference. The battery level can be checked if connected to

PHONE: (800) 288.1161

[www.akronbrass.com](http://www.akronbrass.com)

a SAM™ SMART NOZZLE and viewed from the nozzle information screen. Additionally, the battery voltage level can be checked on the battery charger's LED screen.

### NOTICE

Only charge one battery per charger slot.

For more information on the charging the batteries, please refer to the Tenergy TN471U battery charger Battery Charger Instruction Manual.

### 9.2.2 INSTALLING BATTERIES

#### ⚠ DANGER

**To prevent ignition of a hazardous atmosphere, batteries must only be changed in an area known to be nonhazardous.**

### NOTICE

Change batteries in a clean dry area to avoid internal contamination.

### NOTICE

Only one battery is required to power the SAM™ SMART NOZZLE. For maximum life, install two batteries.

Unscrew the battery cap thumbscrew by turning it counterclockwise and remove the battery cover. Remove the depleted batteries and place in the battery charger for recharging. Insert freshly charged batteries. Observe polarity for proper (+) and (-) placement. Before replacing the battery cover, inspect and remove any dust or dirt on the mating surfaces of the battery cover and housing. Replace battery cap and tighten the thumbscrew until it will not turn.

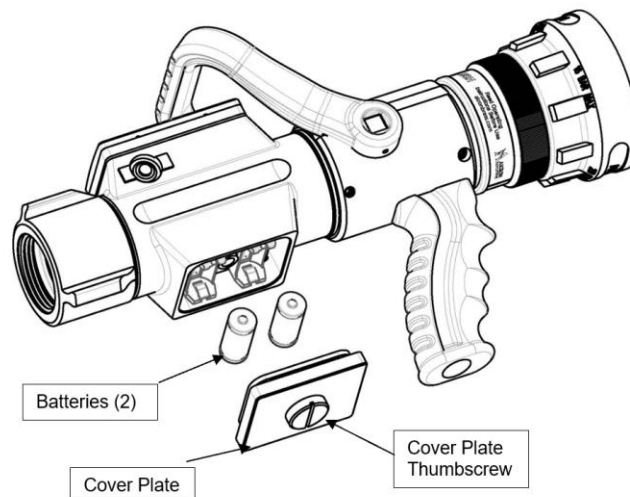

### 9.2.3 STORING BATTERIES

When batteries will not be used and placed into long term storage such as being taken out of service for many months, they should be stored in a cool, dry place and at 40% (3.86V) charge. The battery level can be checked if connected to a SAM™ SMART NOZZLE and viewed from the nozzle information screen. Make sure to fully charge batteries prior to use when removing from long term storage.

### 9.2.4 DISPOSING OF BATTERIES

Do not dispose of the batteries in your regular trash pickup. They must be taken to a location that will properly recycle them.

PHONE: (800) 288.1161

[www.akronbrass.com](http://www.akronbrass.com)



# SAM BOOST™ WITH SMART NOZZLE N<sub>2</sub>P INSTALLATION, OPERATING, & MAINTENANCE MANUAL

## 9.2.5 SAFETY



- Keep batteries in a battery safe container when not installed in a SAM™ SMART NOZZLE.
- Do not expose batteries to high temperature.
- Do not charge batteries unattended.
- Do not disassemble or modify battery.
- Do not short circuit battery.
- Do not dispose of batteries in a fire.

Using any battery other than Hale Products P/N 200-00173-000 can potentially damage your SAM™ SMART NOZZLE. Failure to do this increases the chance of fire and will void your warranty.

## 9.3 Akron Valve Maintenance

Please review Akron Brass document 127903 for list of valve parts.

Action	Cadence
Exercise Valve	Weekly
Pressure Calibration	Annually
Clean out sensor	As needed

### 9.3.1 Akron Valve Exercise

It is recommended to actuate the valves weekly to ensure proper performance and valve lubrication. This applies to both discharge valves and the tank-to-pump valve. Follow the steps below:

1. Tank-to-pump exercise
  - a. Go to Home Page
  - b. Hold the + button to open valve fully
  - c. Hold the – button to close valve fully
2. Discharge valve exercise
  - a. Go to valve control page.
  - b. Hold the up arrow button to open valve fully
  - c. Hit the close button to close valve fully.

### 9.3.2 Akron Valve Pressure Calibration

It is recommended to calibrate the pressure transducers annually. Please follow the steps in the “Pressure Calibration Password” Section of this manual to calibrate sensors.

If the sensor is ever not performing appropriately, then remove sensor, inspect sensor and line for debris and clean out as needed.



This calibration will also calibrate the Master intake and discharge pressure transducers.

PHONE: (800) 288.1161

[www.akronbrass.com](http://www.akronbrass.com)

### 9.4 Pump Vent Solenoid Maintenance

Action	Cadence
Check Pump Vent Solenoid Strainer	Annually

It is recommended to check the pencil strainer located on the pump vent solenoid annually. Follow the steps below:

1. Locate pump vent solenoid on discharge side of pump



2. Remove pump vent solenoid.
3. Inspect pencil strainer



4. Clean or replace if clogged.

### 9.5 Master Pressure Transducer Maintenance

Action	Cadence
--------	---------

PHONE: (800) 288.1161

[www.akronbrass.com](http://www.akronbrass.com)





## SAM BOOST™ WITH SMART NOZZLE N<sub>2</sub>P INSTALLATION, OPERATING, & MAINTENANCE MANUAL

Calibrate sensor	Annually
Clean out sensor	As Needed

It is recommended to calibrate the master discharge and intake pressure transducers annually. Please follow the steps in the “Pressure Calibration Password” Section of this manual to calibrate sensors.

If the sensor is ever not performing appropriately, then remove sensor, inspect sensor and line for debris and clean out as needed.

### 9.6 Tank Level Sensor Maintenance

Action	Cadence
Calibrate sensor	As Needed
Clean out sensor	As Needed

If the sensor is ever not performing appropriately, then remove sensor, inspect sensor and line for debris and clean out as needed.

If the tank level low warning isn’t going off at approximately a quarter tank then the sensor may need to be recalibrated. Follow the tank level calibration instruction in the Password section of this manual.

## 10. REPLACEMENT PARTS

See drawing FSG-PL-01530 for list of replacement parts

nozzle that has been dismantled. Contact factory for technical support.

## 11. MANUFACTURER INFORMATION & WARRANTY

This section provides a list that includes the name, address, and telephone number of the manufacturer’s points of contact. Each provides the name, address, and telephone number of the manufacturer’s representative and/or service organization that can provide replacements and is most convenient to the project sight.

### 11.1 MANUFACTURER’S INFORMATION

Additionally, included herein is warranty information.

DIVISION	ADDRESS	TELEPHONE
<b>Akron Brass</b>	Mailing: 1615 Old Mansfield Road, Wooster, OH 44691 Website: <a href="http://www.akronbrass.com">www.akronbrass.com</a>	(800)-228-1161

PHONE: (800) 288.1161

[www.akronbrass.com](http://www.akronbrass.com)



## SAM BOOST™ WITH SMART NOZZLE N<sub>2</sub>P INSTALLATION, OPERATING, & MAINTENANCE MANUAL

### 11.2 WARRANTY

See the Akron website ([www.akronbrass.com](http://www.akronbrass.com)) for product specific warranty & warranty procedures.

### 12. PRODUCT RATINGS



**This product is not intended for environments that contain explosive gases and has not been certified for these environments.**

- Input Power Requirements: 3.7 V via Hale Products Batteries P/N 200-00173-000. Unit has space for two batteries, but only one battery is needed to power the SAM™ SMART NOZZLE. Maximum useful life between battery changes will be obtained with the use of two installed batteries.
- Controller Power Consumption
  - Standby State: 0.6 mW
  - On Receive: 210 mW
  - On Transmit: 1.2 W<sup>1</sup>
- Nominal Battery Life exceeds 8 hours total under typical conditions, from fully charged batteries. Extreme heat and cold can affect battery life.
- RF Radio
  - Output Power: 30 dBm (1 W)
  - Operating Frequency: 915 MHz
  - FCC ID: 2A679-XBPSX6065
  - IC ID: 28827-XBPSX6065
  - Operational range: 300 feet (91.44 m)
  - SAR value: 1.19 (1-g) W/kg, 0.65 (10-g) W/kg
- Wi-Fi Radio
  - Wi-Fi radio is normally off and can only be activated for diagnostics and upgrades
  - Output Power: 20 dBm (100 mW)
  - Operating Frequency: 2.4 – 2.5 GHz
  - FCC ID: 2AC7Z-ESPWROOM02D
  - IC ID: 21098-ESPWROOM02D
  - Protocol 802.11 b/g/n
  - Operational range: 10 feet (3.048 m)
- Environmental Conditions:
  - Operating Temperature: -20 °C (-4 °F) to 60 °C (140 °F).
  - Storage Temperature: -10 °C (14 °F) to 30 °C (86 °F) Batteries; -20 °C (-4 °F) to 60 °C (140 °F) SAM™ SMART NOZZLE
  - Power management: Automatic shutdown and sleep mode
  - Ingress protection: IP67 equivalent

#### 12.1 FCC NOTICES

Change or modifications that are not expressly approved by the manufacturer could void the user's authority to operate the equipment. (Per FCC Part 15.21)

This device complies with part 15 of the FCC Rules. Operation is subject to the following two conditions: (1) This device may not cause harmful interference, and (2) this device must accept any interference received, including interference that may cause undesired operation. (Per FCC Part 15.19)

<sup>1</sup> Transmission at this power level is for less than 20 ms for each SAM nozzle poll response.

PHONE: (800) 288.1161

[www.akronbrass.com](http://www.akronbrass.com)



## SAM BOOST™ WITH SMART NOZZLE N<sub>2</sub>P INSTALLATION, OPERATING, & MAINTENANCE MANUAL

Note: This equipment has been tested and found to comply with the limits for a Class B digital device, pursuant to part 15 of the FCC Rules. These limits are designed to provide reasonable protection against harmful interference in a residential installation. This equipment generates, uses and can radiate radio frequency energy and, if not installed and used in accordance with the instructions, may cause harmful interference to radio communications. However, there is no guarantee that interference will not occur in a particular installation. If this equipment does cause harmful interference to radio or television reception, which can be determined by turning the equipment off and on, the user is encouraged to try to correct the interference by one or more of the following measures as applicable (Per FCC Part 15.105):

- Reorient or relocate the antenna.
- Increase the separation between the equipment and receiver.
- Connect the equipment into a circuit different from that to which the receiver is connected.
- Consult the dealer or the factory for assistance.

### 12.2 ISED NOTICE (ENGLISH & FRENCH)

This device contains license-exempt transmitter(s)/receiver(s) that comply with Innovation, Science and Economic Development Canada's license-exempt RSS(s). Operation is subject to the following two conditions:

1. This device may not cause interference.
2. This device must accept any interference, including interference that may cause undesired operation of the device.

(Per RSS-Gen Section 8.4)

Cet appareil contient un ou des émetteurs/récepteurs exempts de licence conformes aux RSS exempts de licence d'Innovation, Sciences et Développement économique Canada. Le fonctionnement est soumis aux deux conditions suivantes:

1. Cet appareil ne doit pas causer d'interférences.
2. Cet appareil doit accepter toutes les interférences, y compris les interférences pouvant entraîner un fonctionnement indésirable de l'appareil.

(Selon RSS-Gen Section 8.4)

PHONE: (800) 288.1161

[www.akronbrass.com](http://www.akronbrass.com)