

## Price List 2021



Issue 1, 1/2021  
P/N 34-068-1

**IDEX**  
FIRE & SAFETY

Amendment Record				
Model: Price List 2021				
Modification No.	Date	Page/s	Amendment	New Issue Number
1	1/1/2021	-	-	Issue 1

---

**Contents**

---

	<b>Page</b>
Welcome	5
1. Vehicle Mounted Pumps - Prima	
Prima P1	6-8
Prima P2	9-11
Delivery Valves	12
Prima SmartCAFS	13
Prima Instrument Panels	15
2. Vehicle Mounted Pumps - KP Range	16-17
3. Vehicle Mounted Pumps - GV Range	18
4. Portable Pumps	18
5. Compressed Air Foam - PTO Driven	19
6. SmartFOAM	20
7. Godiva Verified Training	22-23
8. Appendix	24
Direction of rotation and gearbox position	24
KP Product Requirement Specification Form	25
9. Opening Letters of Credit	26
10. Customer Support Documents	27



---

**Welcome**

---

Welcome to the Godiva 2021 price list

2020 was a year like no other. At Godiva we were able to adapt quickly to those challenging times and to be able to carry on serving you with minimal disruption so you could continue to serve first responders.

At Godiva, we put customers at the heart of what we do. Therefore, we listened to your requirements and have amended some of our items on our **PRIMA SELECT** Program. Our Prima select program was created in order to improve lead-time in our Prima Pump range. The Prima Select options are easily identifiable highlighted in yellow in the price list

In 2021, we will continuously challenge ourselves to produce the best products and services for you. Giving you the best customer experience in the industry is our aim.

Please note that the packaging fees for standard vehicle mounted pumps, portable pumps and CAFs vehicle pumps are included in the cost of the product. All other packing requirements outside of the above will be price on application. We trade in accordance with Incoterms® 2010. Prices are strictly ex-works, in line with the Terms and Conditions on our website [www.godiva.co.uk](http://www.godiva.co.uk). This price list is valid for the sale of Godiva brand products from January 2021 until 31st December 2021.

Godiva Ltd. reserves the right to amend prices as required by cost or currency fluctuation; however we will do our utmost to minimise the impact of such an occurrence should it arise.

All prices are in £ sterling. Foreign currency transactions in US \$ and Euros € will be converted to £ sterling using the following exchange rates of \$1.30 : £1.00 and €1.17 : £1.00 during 2021 provided any deviation of the Bank of England spot rate does not exceed +/- 10%. Please note the use of a space to indicate the thousand separator in the prices, e.g. 1 000 = 1,000 (UK/US) or 1.000 (Germany and other countries).

Please note that the new international agreements following Brexit, from the 1st Jan 2021 have not been confirmed. We have reviewed our supply chain and taken steps to ensure supply chain continuity and decided not to action any price alterations as these were unknown at time of publishing. However, we will review any impacts of Brexit with the new international agreements and communicate those accordingly.

We reserve the right to apply additional charges where payment by letter of credit is requested. All products are supplied with an operator's manual in English as standard (in Adobe pdf format on a USB or from the website [www.godiva.co.uk](http://www.godiva.co.uk)), other languages can be supplied by prior agreement at time of order.

Please note that this Price List is on restricted circulation. On no account should it be photocopied or circulated to third parties without our prior written permission.

Thank you for your continued custom and support. We remain committed to putting you, the customer, at the heart of what we do and look forward to serving your fire suppression needs throughout 2021. We continually welcome feedback from you, please feel free to leave your feedback at [godivafeedback@idexcorp.com](mailto:godivafeedback@idexcorp.com).

Godiva Limited

January 2021

# 1. Vehicle Mounted Pumps - Prima

## P1 Range

## Single Pressure Pump

Price £

Choose the core pump then add the required component parts.

Note: when ordering a pump please use the Product Requirement Specification Form, to define the required pump. Unless a completed specification sheet is submitted we cannot guarantee the requested delivery date.

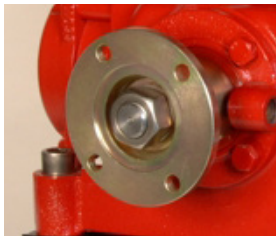
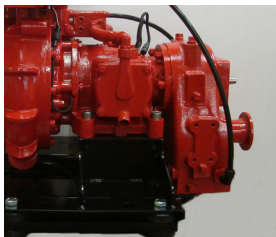
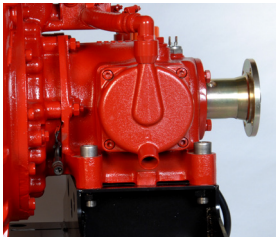

	2010 Model	3010 Model	4010 Model	6010 Model
<b>Core pump - clockwise or counter clockwise rotations</b>				
Aluminium	7 125	7 125	8 092	11 126
Gunmetal	7 846	7 846	8 850	14 369
<b>Note: core pump includes bearing housing, mounting base, volute, impeller, paint, labels, testing costs and all necessary blanking plates when certain options are not used, e.g. RTP foam, additional valves and outriggers</b>				
<b>Priming system</b>				
Piston primer (NB: only gunmetal available, suitable for both directions of rotation)	2 933			
Water ring primer, friction drive, aluminium	4 030			
Water ring primer, friction drive, gunmetal	4 575			
<b>Note: water ring primer, friction drive, not available with gearbox or counter clockwise rotation pumps (when viewed on drive flange of pump)</b>				
No primer - aluminium pumps or gunmetal pumps	231	231	231	231
<b>Gearbox (right, left, down positions) ratios supplied -</b>				
1.24:1	2 536			
1.40:1	2 536			
1.59:1	2 536			
1.80:1	2 536			
1.97:1	2 536			
2.16:1	2 536			
2.37:1	2 536			
<b>Drive flange</b>				
SAE 1410	142			
SAE 1510	126			
DIN 100	101			
DIN 120/8	130			
WRP1410, friction drive	Included with water ring primer			
WRP1510, friction drive	Included with water ring primer			
<b>Outrigger section, elbows to support outside valves</b>				
Blanks only, aluminium (2 valves)	101			
Blanks only, gunmetal (2 valves)	261			
For 3 valves, aluminium (1 x outrigger elbow, 1 x blank supplied)	168			
For 3 valves, gunmetal (1 x outrigger elbow, 1 x blank supplied)	439			
For 4 valves, aluminium (2 x outrigger elbows supplied)	231			
For 4 valves, gunmetal (2 x outrigger elbows supplied)	622			
<b>Note: a monitor feed can be sold separately.</b>				

**PRIMA SELECT**  
= **Parts in yellow box**

**What is Prima Select -**

- Reduce lead time
- Better parts availability
- Product simplification

*Please ask about our Prima Select Programme*

**1. Vehicle Mounted Pumps - Prima**

**P1 Range**

**Single Pressure Pump**

Choose the core pump then add the required component parts.



Note: when ordering a pump please use the Product Requirement Specification Form, to define the required pump. Unless a completed specification sheet is submitted we cannot guarantee the requested delivery date.

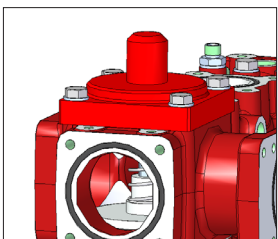

	2010 Model	3010 Model	4010 Model	6010 Model
<b>Suction tubes</b>				
4" RT, 0° suction droop, aluminium	658			
4" RT, 0° suction droop, gunmetal	956			
4" RT, 25° suction droop, aluminium	<b>639</b>			
4" RT, 25° suction droop, gunmetal	<b>774</b>			
4" BSP, 0° suction droop, aluminium	<b>377</b>			
4" BSP, 0° suction droop, gunmetal	521			
4" BSP, 25° suction droop, aluminium	<b>383</b>			
4" BSP, 25° suction droop, gunmetal	661			
DIN 175 stub flange, aluminium	<b>Included in core price</b>			
DIN 175 stub flange, gunmetal	<b>Included in core price</b>			
5.5" RT, 25° suction droop, aluminium		<b>713</b>	<b>739</b>	
5.5" RT, 25° suction droop, gunmetal		1 096	<b>1 396</b>	
5.5" BSP, 0° suction droop, aluminium		<b>396</b>	1 403	
5.5" BSP, 0° suction droop, gunmetal		646	2 077	
5.5" BSP, 25° suction droop, aluminium		394	1 479	
5.5" BSP, 25° suction droop, gunmetal		606	1 981	
DN125 PN16 stub Flange, aluminium			<b>Included in core price</b>	
DN125 PN16 stub Flange, gunmetal			<b>Included in core price</b>	
DN200 PN16 stub suction only, aluminium				Included in core price
DN200 PN16 stub suction only, gunmetal				Included in core price
<b>P1 Volute outlet</b>				
Manifold, 6 way, aluminium	<b>305</b>	<b>305</b>	<b>424</b>	<b>424</b>
Manifold, 6 way, gunmetal	<b>539</b>	<b>539</b>	<b>707</b>	<b>707</b>
Manifold with check valve, aluminium (China CCC requirement) Not compatible with proportional foam system	1 091			
Manifold with check valve, gunmetal Not compatible with proportional foam system	1 119			
<b>Note: if a manifold is not fitted the core price includes a trumpet outlet design, with the following connections - 2010 - 3" PN16, 3010 - 4" PN16, 4010 5" PN16, 6010 - 5" PN16</b>				



**PRIMA SELECT**  = **Parts in yellow box**

- What is Prima Select -**
-  Reduce lead time
  -  Better parts availability
  -  Product simplification
- Please ask about our Prima Select Programme*

**1. Vehicle Mounted Pumps - Prima**

**P1 Range**

**Single Pressure Pump**

Choose the core pump then add the required component parts.

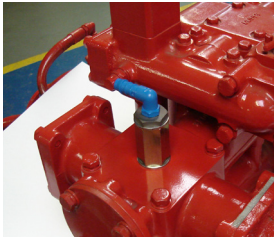
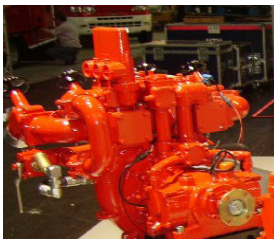
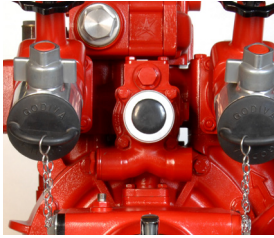

**Note:** when ordering a pump please use the Product Requirement Specification Form, to define the required pump. Unless a completed specification sheet is submitted we cannot guarantee the requested delivery date.



	2010 Model	3010 Model	4010 Model	6010 Model
<b>Round the pump foam system - RTP</b>				
120 l/min foam system, aluminium		<b>1 149</b>		
120 l/min foam system, gunmetal		<b>1 536</b>		
<b>Proportional RTP</b>				
Guaranteed 1% Class A foam, 3% or 6% Class B foam, aluminium		2 319		
Guaranteed 1% Class A foam, 3% or 6% Class B foam, gunmetal		2 768		
<b>Thermal relief valve</b>				
Activates at 42°	p/n 60809		<b>253</b>	
Activates at 74°	p/n 60809/01		<b>253</b>	
<b>Paint finish</b>				
Standard "post office" red			<b>included in core price</b>	
Other colours			213	
<b>Collecting heads</b>				
2 ports, Aluminium, BS Instantaneous			<b>1 002</b>	
2 ports, Gunmetal, BS Instantaneous			<b>2 045</b>	
4 (2+2 combination, left, right or under suction tube), Alum.			2 053	
4 (2+2 combination, left, right or under suction tube), GM			4 157	

**PRIMA SELECT**  = **Parts in yellow box**

**What is Prima Select -**

-  **Reduce lead time**
-  **Better parts availability**
-  **Product simplification**

*Please ask about our Prima Select Programme*

## 1. Vehicle Mounted Pumps - Prima

### P2 Range

### Multi-Pressure Pump

Choose the core pump then add the required component parts.

**Note:** when ordering a pump please use the Product Requirement Specification Form , to define the required pump. Unless a completed specification sheet is submitted we cannot guarantee the requested delivery date.

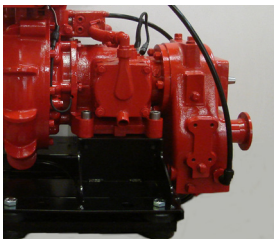
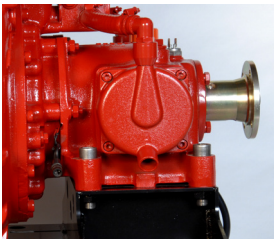

Core pump - clockwise or counter clockwise rotations	2010 Model	3010 Model	4010 Model	6010 Model
Aluminium	10 107	10 107	11 435	13 217
Gunmetal	12 177	12 177	14 484	15 786
<b>Note: core pump includes bearing housing, mounting base, volute, impeller, thermal relief valve, paint, labels, testing costs and all necessary blanking plates when certain options are not used, e.g. RTP foam, additional valves and outriggers</b>				
<b>Priming system</b>				
Piston primer (NB: only gunmetal available, suitable for both directions of rotation)	2 933			
Water ring primer, friction drive, aluminium	4 030			
Water ring primer, friction drive, gunmetal	4 575			
<b>Note: water ring primer, friction drive, not available with gearbox or counter clockwise rotation pumps (when viewed on drive flange of pump)</b>				
No primer - aluminium or gunmetal pumps	231	231	231	231
<b>Gearbox (right, left, down positions) ratios supplied -</b>				
1.24:1	2 536			
1.40:1	2 536			
1.59:1	2 536			
1.80:1	2 536			
1.97:1	2 536			
2.16:1	2 536			
2.37:1	2 536			
<b>Drive flange</b>				
SAE 1410	142			
SAE 1510	126			
DIN 100	101			
DIN 120/8	130			
WRP1410, friction drive	Included with water ring primer			
WRP1510, friction drive	Included with water ring primer			
<b>Outrigger section, elbows to support outside valves</b>				
Blanks only, aluminium (2 valves)	101			
Blanks only, gunmetal (2 valves)	261			
3 valves, aluminium (1 x outrigger elbow, 1 x blank supplied)	168			
3 valves, gunmetal (1 x outrigger elbow, 1 x blank supplied)	439			
4 valves, aluminium (2 x outrigger elbows supplied)	231			
4 valves, gunmetal (2 x outrigger elbows supplied)	622			
<b>Note: a monitor feed can be sold separately.</b>				

**PRIMA SELECT**  
= **Parts in yellow box**



**What is Prima Select -**

Reduce lead time



Better parts availability



Product simplification

*Please ask about our Prima Select Programme*

# 1. Vehicle Mounted Pumps - Prima

## P2 Range

## Multi-Pressure Pump

Price £

Choose the core pump then add the required component parts.

**Note:** when ordering a pump please use the Product Requirement Specification Form, to define the required pump. Unless a completed specification sheet is submitted we cannot guarantee the requested delivery date.



	2010 Model	3010 Model	4010 Model	6010 Model
<b>Suction tubes</b>				
4" RT, 0° suction droop, aluminium	658			
4" RT, 0° suction droop, gunmetal	956			
4" RT, 25° suction droop, aluminium	<b>639</b>			
4" RT, 25° suction droop, gunmetal	<b>774</b>			
4" BSP, 0° suction droop, aluminium	<b>377</b>			
4" BSP, 0° suction droop, gunmetal	521			
4" BSP, 25° suction droop, aluminium	<b>383</b>			
4" BSP, 25° suction droop, gunmetal	661			
DIN 175 stub flange, aluminium	<b>Included in core price</b>			
DIN 175 stub flange, gunmetal	<b>Included in core price</b>			
5.5" RT, 25° suction droop, aluminium		<b>713</b>	<b>739</b>	
5.5" RT, 25° suction droop, gunmetal		1096	<b>1 396</b>	
5.5" BSP, 0° suction droop, aluminium		<b>396</b>	1 403	
5.5" BSP, 0° suction droop, gunmetal		646	2 077	
5.5" BSP, 25° suction droop, aluminium		394	1 497	
5.5" BSP, 25° suction droop, gunmetal		606	1 981	
DN125 PN16 stub Flange, aluminium			Included in core price	
DN125 PN16 stub Flange, gunmetal			Included in core price	
DN200 PN16 stub suction only, aluminium				Included in core price
DN200 PN16 stub suction only, gunmetal				Included in core price
<b>P2 - High/low pressure selector</b>				
Electro-pneumatic operated ball valve	<b>573</b>			
<b>Note: a manually operated lever is fitted as standard</b>				
<b>High pressure outlet connections</b>				
1 1/4" BSP top or rear	<b>77</b>			
Twin side 1" BSP, side facing, top mounted	<b>299</b>			
Twin electro-pneumatic 1" BSP top mount, side facing	1 224			
<b>Note: all top mounted high pressure outlets are not available with proportional RTP or the high pressure RTP foam system</b> <b>All electro-pneumatic options require that compressed air is available on the vehicle</b>				
<b>Manifold with check valve</b>				
Manifold with check valve, aluminium (China CCC requirement)	727			
Manifold with check valve, gunmetal (China CCC requirement)	755			
<b>Note: These manifolds are not compatible with the proportional foam system</b>				

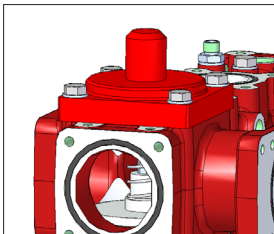

**PRIMA SELECT** = **Parts in yellow box**

- What is Prima Select -**
- Reduce lead time
  - Better parts availability
  - Product simplification
- Please ask about our Prima Select Programme*

**1. Vehicle Mounted Pumps - Prima**

**P2 Range**

**Multi-Pressure Pump**

Choose the core pump then add the required component parts.

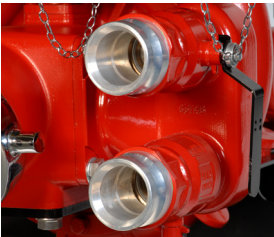
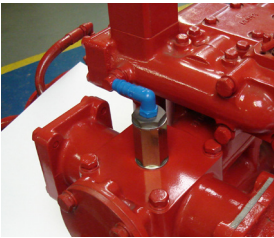
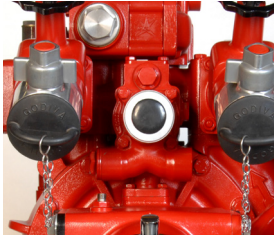

**Note:** when ordering a pump please use the Product Requirement Specification Form, to define the required pump. Unless a completed specification sheet is submitted we cannot guarantee the requested delivery date.



	2010 Model	3010 Model	4010 Model	6010 Model
<b>Round the pump foam system - RTP</b>				
Low pressure discharge foam system, 120 l/min, aluminium		<b>1 149</b>		
Low pressure discharge foam system, 120 l/min, gunmetal		<b>1 536</b>		
Low and High pressure discharge foam system (fixed foam flow rate), aluminium		1 668		
Low and High pressure discharge foam system (fixed foam flow rate), gunmetal		2 683		
Low and High pressure discharge foam system with metering control (variable foam flow rate), aluminium		2 294		
Low and High pressure discharge foam system with metering control (variable foam flow rate), gunmetal		3 243		
<b>Proportional RTP</b>				
Guaranteed 1% Class A foam, 3% or 6% Class B foam, aluminium		2 319		
Guaranteed 1% Class A foam, 3% or 6% Class B foam, gunmetal		2 768		
<b>Note: the foam proportional RTP is not compatible with the standard Prima panel, please contact your Godiva Regional Sales Manager to discuss the possible options.</b>				
<b>Thermal relief valve</b>				
Activates at 42°	p/n 60809		<b>Included in core price</b>	
Activates at 74°	p/n 60809/01		<b>Included in core price</b>	
<b>Paint finish</b>				
Standard "post office" red			<b>included in core price</b>	
Other colours		213		
<b>Collecting heads</b>				
2 ports, Aluminium, BS Instantaneous		<b>1 002</b>		
2 ports, Gunmetal, BS Instantaneous		<b>2 045</b>		
4 (2+2 combination, left, right or under suction tube), Alum.		2 053		
4 (2+2 combination, left, right or under suction tube), GM		4 157		

**PRIMA SELECT**  = **Parts in yellow box**

**What is Prima Select -**

-  Reduce lead time
-  Better parts availability
-  Product simplification

*Please ask about our Prima Select Programme*

## 1. Vehicle Mounted Pumps - Delivery Valves

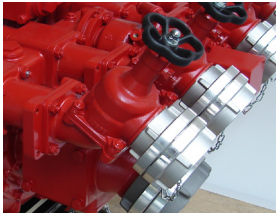

### Delivery valves and other accessories



Valve type	Connection type	aluminium	gunmetal
		per valve	per valve
Standard Godiva with handwheel	2.5" instantaneous connection	<b>409</b>	<b>534</b>
Standard Godiva with crank handle	2.5" instantaneous connection	<b>424</b>	<b>545</b>
Dual flow valve	2.5" instantaneous connection	778	<b>1 067</b>
Ball valve	2.5" instantaneous connection	1 032	1 400
	2.5" BSP	665	1 005
Continental valve with handwheel	2.5" instantaneous connection	431	<b>815</b>
	<b>2.5" BSP</b>	<b>290</b>	<b>582</b>
	2.5" 65mm or 75mm Storz	432	718
Continental valve with crank handle	<b>2.5" instantaneous connection</b>	<b>501</b>	<b>888</b>
	<b>2.5" BSP</b>	<b>410</b>	<b>670</b>
	2.5" 65mm or 75mm Storz	507	806
<b>ESP - electric motor driven primer, alternative to piston primer</b>			
Electric rotary vane, oil-less priming pump, 12V		734	
Electric rotary vane, oil-less priming pump, 24V		1 177	

**PRIMA SELECT**  = **Parts in yellow box**

#### What is Prima Select -

-  Reduce lead time
-  Better parts availability
-  Product simplification

*Please ask about our Prima Select Programme*

# 1. Vehicle Mounted Pumps - Prima UV SmartCAFS

## Vehicle mounted pump with compressed air foam

CAFS system price is made up from selection for A + B + C + D + E. Optionally also add valve costs below, and other standard pump options

Prima CAFS core prices		2010	3010	4010	6010
A	PC1A+	52 086	52 373	53 501	56 556
	PC2A+	56 126	56 405	58 524	73 340
	PC1B+	60 441	60 738	62 295	62 837
	PC2B+	65 622	65 921	67 476	82 048

CAFS Core price includes: UV SmartCAFS controller, pump with piston primer, gearbox mounted on base with integral drains, thermal relief valve, PrimaCAFS wide instrument panel, 3-off water delivery valves + 1 upward facing monitor feed port (blanked), 1-off CAFS delivery valve, suction tube, electronic foam proportioner model 2.1A, water level indicator, foam level indicator, filters, level switch and ancillaries supplied loose. Please check installation/operation manual for details.

PC2 Prices includes 45-45 Manual HP-LP changeover, Twin 1" BSP HP Outlet and MDT valve.

Additional fee chargeable for Collecting heads, Pneumatic HP-LP changeover and Pneumatic HP delivery valves. See main price list for details.

Foam Proportioning System		2010	3010	4010	6010
B	2.1A System, Class A only	Included in core prices			
	3.3 Single foam System, A or B	4 811			
	3.3 Dual foam System, A and B	6 154			
	5.0 Single foam System, A or B	5 277			
	5.0 Dual foam System, A and B	6 621			
	6.5 Single foam System, A or B			5 744	
	6.5 Dual foam System, A and B			7 087	
	Twin 6.5, Dual foam System, A and B			12 133	

Note: All Dual Foam systems include an MDT valve as standard and a foam level indicator for the second tank. If an ADT selector valve is required see "Foam Tank Selection Valves" below

Foam tank selection valves		2010	3010	4010	6010
C	To replace MDT with ADT valve on Dual Foam Systems	659			

Note: ADT not available on 6.5 systems. For single foam tank systems a selector/flush valve is not essential, if one is required it can be ordered under part number 538-1490-04-0.

Engine control options		2010	3010	4010	6010
D	SmartCAFS only panel (no engine control)	Deduct 1 726			
	SmartCAFS with Standard engine control	Included in core price			
	SmartCAFS and SmartGov Engine Control	2 925			
	SmartCAFS and SmartGov with Twister	3 613			
	SmartCAFS UV additional panel	4 576			

Note: All tank and foam level gauges are ITL40 models. See illustrations on next page.

		2010	3010	4010	6010	
E	50 CFM (Cubic Feet/Minute)	Included in core prices				See note 1
	100 CFM	7 310				See note 1
	200 CFM	8 441				See note 2

Note 1: 50 & 100CFM units have integral compressor/separator tank & CAFS manifold mounted on pump.

Note 2: 200 CFM units have compressor only mounted on pump, separator and CAFS manifold supplied separately

**1. Vehicle Mounted Pumps - Prima UV SmartCAFS panel options**

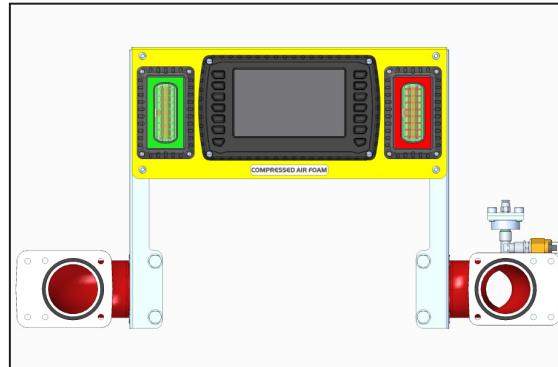

SmartCAFS only panel

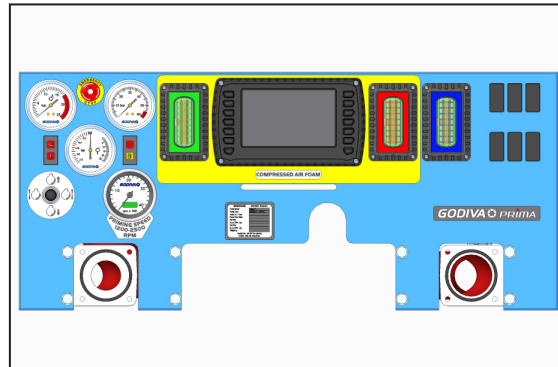

SmartCAFS with Standard Engine control

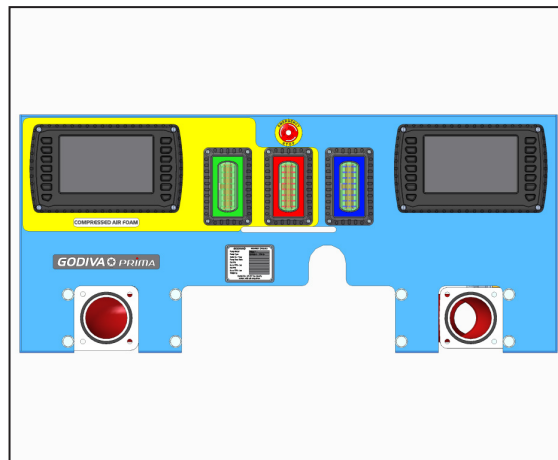

SmartCAFS, SmartGOV control

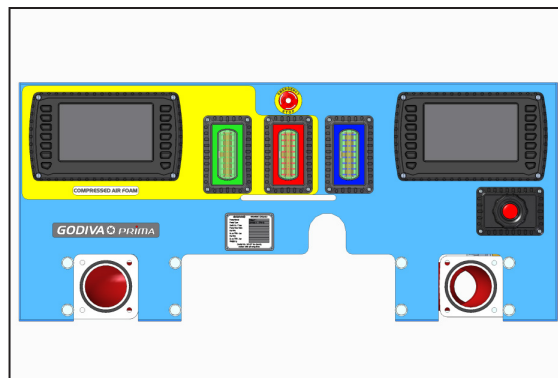

SmartCAFS, SmartGOV control with Twister

**1. Prima Instrument panel options**

**For Prima pumps**

**P1 Single pressure panel - water only**

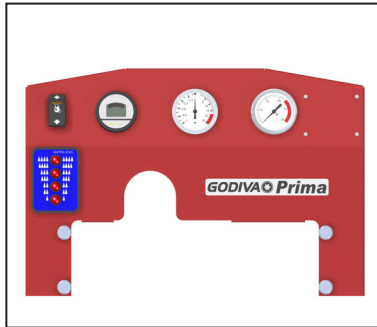

Plastic coated steel panel, width 490mm  
 Speed up / down  
 Tachometer/hours meter  
 Discharge pressure gauge  
 Suction pressure gauge  
 ITL4 (intelli-tank) water gauge  
 Note: this panel not compatible with the proportional RTP foam system, but will accept the standard RTP (120l/min)

**2 126**

**P2 Twin pressure panel - water only**

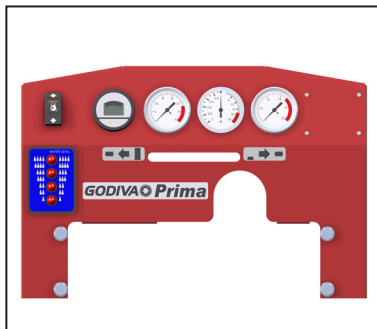

Plastic coated steel panel, width 490mm  
 Speed up / down  
 Tachometer/hours meter  
 Discharge pressure gauge  
 Suction pressure gauge  
 ITL4 (intelli-tank) water gauge  
 High pressure gauge  
 Note: this panel not compatible with the proportional RTP foam system or the high pressure RTP foam system, but will accept the standard RTP (120l/min)

**2 392**

**P1 Single pressure panel - water and foam**

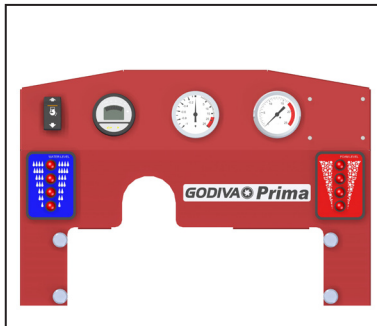

Plastic coated steel panel, width 490mm  
 Speed up / down  
 Tachometer/hours meter  
 Discharge pressure gauge  
 Suction pressure gauge  
 ITL4 (intelli-tank) water gauge  
 ITL4 (intelli-tank) foam gauge  
 Note: this panel not compatible with the proportional RTP foam system, but will accept the standard RTP (120l/min)

**2 392**

**P2 Twin pressure panel - water and foam**

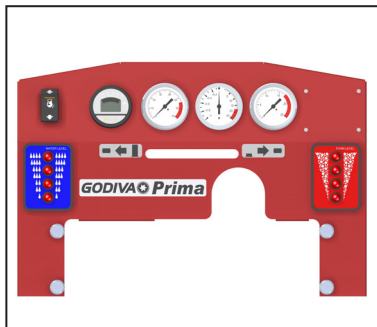

Plastic coated steel panel, width 490mm  
 Speed up / down  
 Tachometer/hours meter  
 Discharge pressure gauge  
 Suction pressure gauge  
 ITL4 (intelli-tank) water gauge  
 ITL4 (intelli-tank) foam gauge  
 High pressure gauge  
 Note: this panel not compatible with the proportional RTP foam system or the high pressure RTP foam system, but will accept the standard RTP (120l/min)

**2 718**

Please note that foam proportioning systems are not compatible with standard panels, please contact your Godiva Regional Sales Manager to discuss the possible options.

**2. Vehicle Mounted Pumps - KP**

**KP Range**

**Single or Multi-Pressure Pump**

Choose the core pump then add the required component parts.

**Note:** when ordering a pump please use the Product Requirement Specification Form on page 24, to define the required pump. Unless a completed specification sheet is submitted we cannot guarantee the requested delivery date.

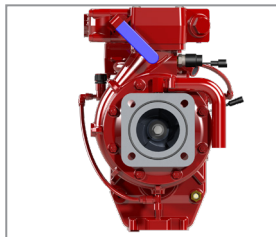
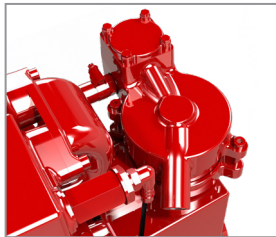
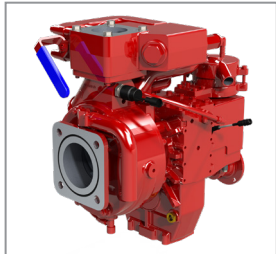

	<b>KP1_1510 Single</b>	<b>KP2_1510 Multi-pressure</b>
<b>Core pump</b>		
Aluminium Clockwise	4 337	6 840
Aluminium Counter Clockwise	4 337	6 840
Gunmetal Clockwise	5 970	9 776
Gunmetal Counter Clockwise	5 970	9 776
<b>As viewed on drive flange of pump</b>		
<b>Priming system</b>		
Piston primer, 12 Volt		1 749
Piston primer, 24 Volt		1 749
No primer		248
Electric rotary vane, oil-less priming pump, 12V shipped loose, must choose no primer option		734
Electric rotary vane, oil-less priming pump, 24V shipped loose, must choose no primer option		1 177
<b>Gear ratio</b>		
1.90:1		Included in core price
2.33:1		Included in core price
2.91:1		Included in core price
<b>Gearbox position</b>		
Down		Included in core price
Left		Included in core price
Right		Included in core price
<b>As viewed from the suction tube end of the pump</b>		
<b>Volute position</b>		
Up		Included in core price
Left	Included in core price	
Right	Included in core price	
<b>As viewed from the suction tube end of the pump</b>		
<b>Drive flange</b>		
SAE 1410		143
DIN 100		103
<b>Volute Outlet</b>		
Standard flanged outlet (115, DN65)		Included in core price
Low pressure discharge tee only, aluminium (blanks only)		240
Low pressure discharge tee only, gunmetal (blanks only)		772
Low pressure discharge tee with (2) outriggers, aluminium (2 outlets)		342
Low pressure discharge tee with (2) outriggers, gunmetal (2 outlets)		1 035
<b>Suction Tubes</b>		
Standard flange (DIN 175, DN 100)		Included in core price
Tank to suction flange, aluminium		334
Tank to suction flange, gunmetal		953
4.5" BSP, 0° suction droop, aluminium		284
4.5" BSP, 0° suction droop, gunmetal		852
4.0" RT, 0° suction droop, aluminium		372
4.0" RT, 0° suction droop, gunmetal		938

**2. Vehicle Mounted Pumps - KP**

**KP Range**

**Single or Multi-Pressure Pump Continued -**

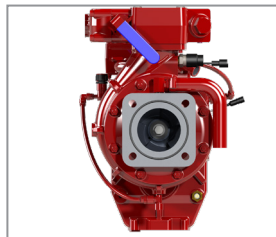
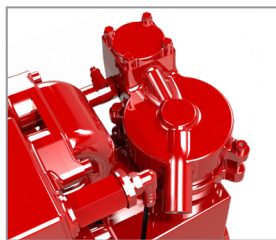

	KP1_1510 Single	KP2_1510 Multi-pressure
<b>Suction tubes - Continued</b>		
4.5" victaulic, 0° suction droop, aluminium		284
4.5" victaulic, 0° suction droop, gunmetal		852
110 Storz, 0° suction droop, aluminium		714
110 Storz, 0° suction droop, gunmetal		1 552
<b>Suction strainers</b>		
110mm Storz or 4" victaulic, 4.5" BSP p/n 51529		83
<b>Thermal relief valve</b>		
Activates at 42° p/n 60809	253	Included in core price
Activates at 74° p/n 60809/01	253	Included in core price
<b>If pump is ordered without low pressure discharge tee the thermal relief valve is shipped loose</b>		
<b>Paint finish</b>		
Standard "post office" red	included in core price	
Other colours	110	
<b>High pressure outlet connections</b>		
1½" BSP side		Included in core price
<b>Gauges</b>		
80mm High pressure 0-60 bar p/n C1-1330014		120
80mm Low pressure 0-25 bar p/n C1-1330013		116
80mm Compound pressure -1 - 25 bar p/n C1-1330015		247
<b>Tachometer</b>		
24V version p/n 168-00056-000		308
12V version p/n 168-00056-001		308
<b>Round the pump foam system</b>		
120 l/min foam system, aluminium		1 154
120 l/min foam system, gunmetal		1 543
Shipped loose		

**Delivery Valves for KP Pumps**

Valve Type	Connection Type	Aluminium per valve	Gunmetal per valve
Standard Godiva with handwheel	2.5" instantaneous connection	409	534
Standard Godiva with crank handle	2.5" instantaneous connection	424	545
Dual flow valve	2.5" instantaneous connection	778	1 067
Ball valve	2.5" instantaneous connection	1 032	1 400
	2.5" BSP	665	1 005
Continental valve with handwheel	2.5" instantaneous connection	431	815
	2.5" BSP	290	582
	2.5" 65mm or 75mm Storz	432	718
Continental valve with crank handle	2.5" instantaneous connection	501	888
	2.5" BSP	410	670
	2.5" 65mm or 75mm Storz	507	806

**3. Vehicle Mounted Pumps - GV Range**

**GVB10000**

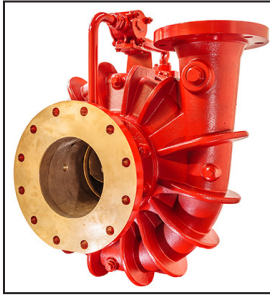

Part number: GVB10000/02  
 Material: **Gunmetal**  
 Connections: **Suction 8" Flanged**  
**Delivery 5" Flanged**  
 Rated performance: Please apply  
 Max flow: 10 000 l/min  
 Max pressure: 22 bar

**27 674**

**4. Portable Pumps**

**Powerflow 8/5**  
**Single**



Part number: GP8/5/20  
 Pump material: Aluminium  
 Connections: Suction 4" RT.  
 Delivery 2.5" I/C  
 Priming: **Exhaust gas ejector**  
 Max. output @ 5bar 800 l/min  
 Rated performance: 500 l/min @ 6 bar  
 Max flow: 1400 l/min @ 3 bar  
 Max pressure: 8.2 Bar  
 Engine: 18 HP, air cooled  
 Starter/ignition: **Electric and recoil**

**5 535**

**Powerflow 8/5**  
**Twin**

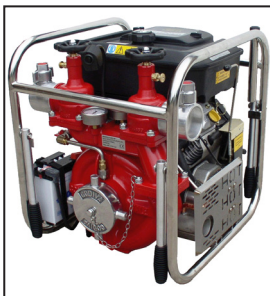

Part number: GP8/5T/01  
 Pump material: Aluminium  
 Connections: Suction 4" R.T.  
 Delivery 2 x 2.5" I/C  
 Priming: Exhaust gas ejector  
 Max. output @ 5bar 800 l/min  
 Rated performance: 500 l/min @ 6 bar  
 Max flow: 1400 l/min @ 3 bar  
 Max pressure: 8.2 Bar  
 Engine: 18 HP, air cooled  
 Starter/ignition: Electric + recoil

**6 621**

**Options at extra cost**

**Price £**

- Flood light 55w - p/n 56504 **356**
- Recommended spares for two years
  - Single discharge pump **415**
  - Twin discharge pump **415**

**Bold text** = features that differentiate this model

**5. Compressed Air Foam - PTO Driven Systems**

**MCP50CAN  
MCP100CAN**

with UV SmartCAFS controller

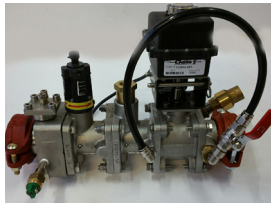

Each system will feature one of these options, depending on the required output capacity -

Mixing Manifold: Connection options - 2" (CAFS50) or 3" (CAFS100) victaulic  
with dual check valve

FoamLogix foam pump: 2.1A, 3.3, 5.0, 6.5  
Foam proportioning rate: 0.1% - 9.9%  
Foam flow rate: 2.1A - 8 l/min  
3.3 - 12.5 l/min  
5.0 - 19 l/min  
6.5 - 25 l/min  
Twin 6.5 50 l/min

Operating pressure range: 0.4-1 Mpa

Compressor: 50, 100 scfm  
with cooling system

Foam Tank selector Valve: MST Single foam or MDTII dual foam  
(select from table below)

System controller: UV700 SmartCAFS controller  
includes Run/standby mode option

	Foam System Price £				
Core System	2.1A	3.3	5.0	6.5	Twin 6.5
MCP50	18 256	18 808	19 313	19 818	24 620
MCP100	22 627	23 180	23 685	24 190	28 991

Valve	Price £
Manual Single Tank w/flush	1 202
Manual Dual Tank w/flush, Note 1	1 877
Air Dual Tank, Note 1, 2	3 300
Automatic Dual Tank, Note 1, 2	3 502

**Notes:**

- 1. Not Suitable for 2.1A Systems
- 2. Not available on 6.5 Systems

**For other foam pump configurations please contact Godiva**

---

## 6. UV SmartFOAM - Foam Proportioning Systems

---

For Foam Proportioning systems please refer to the Hale Order Form - P.O.A.



### UV SmartFOAM Controller

P.O.A.

Utilising the Class1 Ultraview 450 module for state of the art foam proportioning

- Computer controlled foam proportioning
- All controls and data display in one unit
- Reliable and accurate flow sensor
- Operator preset of foam percentages
- Display of foam and water usage
- Configurable display formats to suit user
- On screen tutorials for calibration and configuration



This page intentionally left blank

---

7. Godiva Verified Training



At Godiva we believe in helping you put your investment to work quickly and productively. Our verified training courses are designed to deliver this, equipping your service personnel with all the knowledge they need. All maintenance courses are delivered by experienced Godiva service engineers.

All prices are based on delivery in the UK. Training outside the UK attracts travel and sustenance costs.

Please contact Godiva Verified Training for a quote  +44 (0)1926 623600  [godivacustomerservice@idexcorp.com](mailto:godivacustomerservice@idexcorp.com)

**Pump Champion Maintenance**

A course designed for experienced workshop personnel, to help consolidate and update their pump knowledge, in preparation for taking a guiding role at their facility. The course will enable Trainees to be a comprehensive source of pump maintenance procedures and workshop tech-

DAY	COURSE
Monday	KP
Tuesday	Portables
Wednesday	Prima
Thursday	Prima UltraviewCAFS
Friday	Prima UltraviewCAFS

**For 2021 four dates are available -**  
 Please be advised that the dates are provisional and subject to the latest Covid-19 restrictions, which may mean the dates are cancelled or postponed.

 **1st-5th March, 7th-11th June, 6th-10th September, 6th-10th December.**  
**£399 per person, per course, per day**

 **Based at Godiva Headquarters**

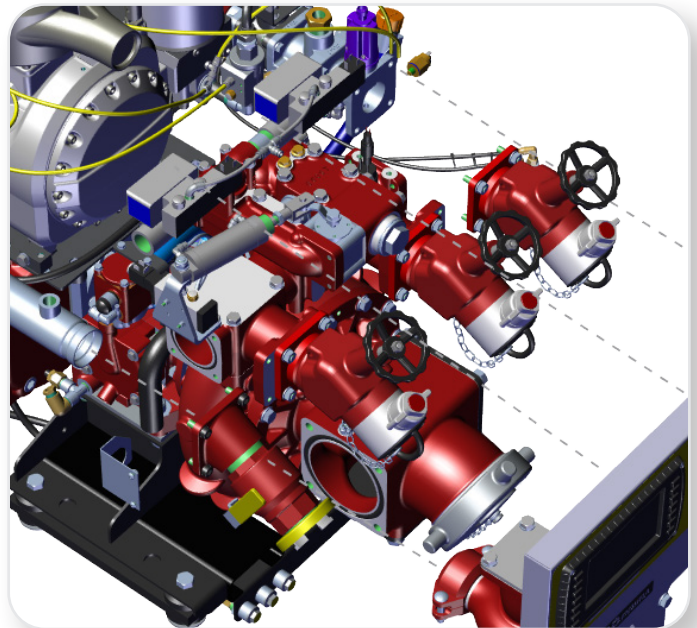

**Portable Maintenance**

For workshop personnel to become familiar with all the required maintenance and repair tasks relating to their brigades portable pump fleet. Course types offered.

COURSE	DURATION
GP8/5 & GP10/10	1 DAY
GP12/10 & GP17/10	1 DAY

 **Based at customer's location**

 **£1600 per day**



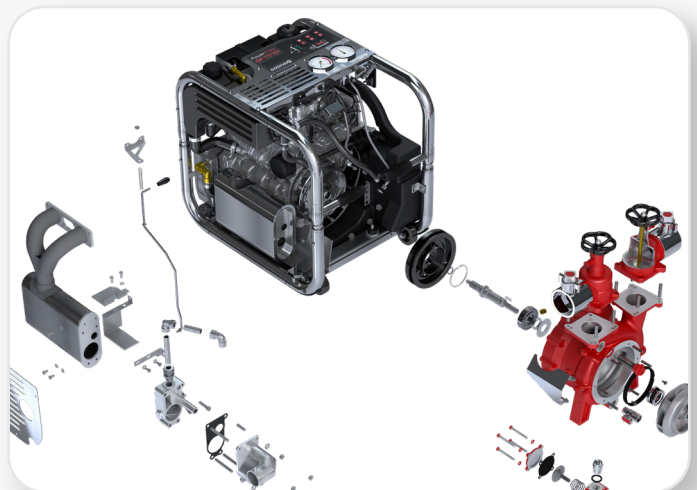

 **Maximum 8 attendees**



## 7. Godiva Verified Training

### Prima Maintenance



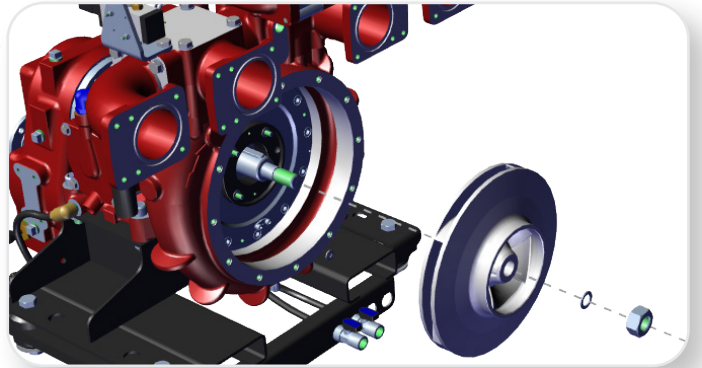

For workshop personnel to gain full maintenance and repair knowledge of this current brigade standard vehicle pump. Acquire the key skills to keep the pump in reliable and consistent condition. Based at customer site.

-  Duration 1 day
-  Based at customer's location
-  £1600 per day
-  Maximum 8 attendees



### World Series Maintenance



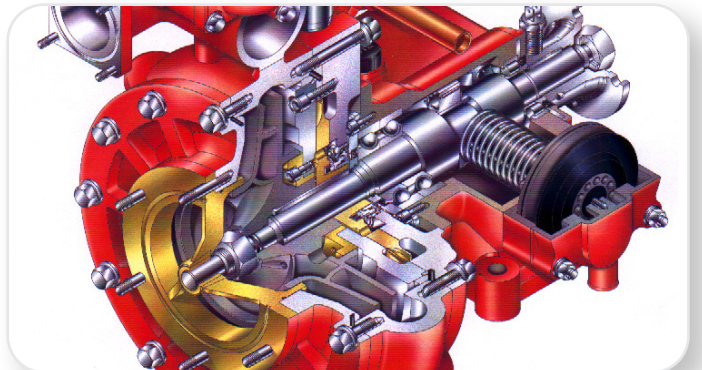

For workshop personnel to gain full maintenance and repair knowledge of this long established brigade vehicle pump. Acquire the key skills to keep the pump in reliable and consistent condition.

-  Duration 1 day
-  Based at customer's location
-  £1600 per day
-  Maximum 8 attendees



### UltraView CAFS Maintenance

For workshop personnel to become familiar with the maintenance and repair of this increasingly popular brigade pump. Learn all the necessary diagnostic techniques to keep the pump and compressed air foam system in top, frontline condition.

-  Duration 2 days
-  Based at customer's location
-  £1800 per day
-  Maximum 8 attendees

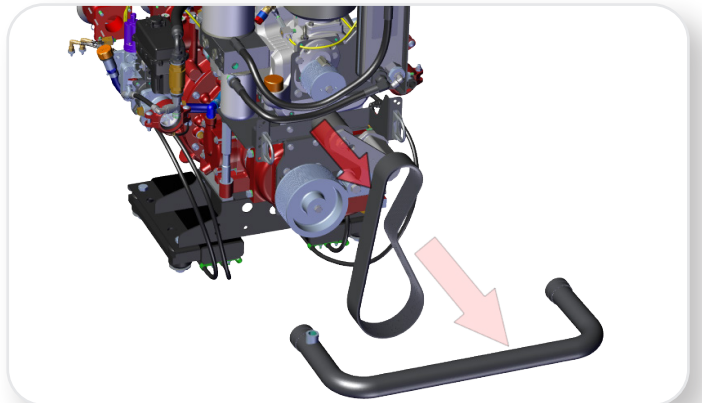

### Older Pump Models

Please note that we also provide maintenance training for certain older pump models.

-  Based at customer's location

Details of these courses are available on request.

---

**8. Appendix - Direction of rotation and gearbox position - Godiva Pumps**

---

**Direction of rotation**

Use this guide to determine the pump direction of rotation required.

Looking at the pump drive flange -

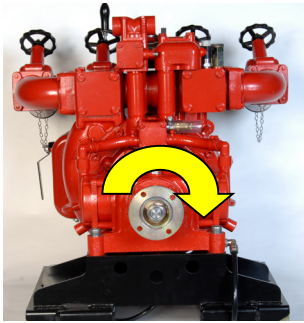

**Clockwise**



**Counter Clockwise**

**Even if a gearbox is fitted, it is the drive flange rotation that is critical.**

**Position of Gearbox**

When ordering a Godiva gearbox, please note the gearbox is available in three different positions. Please specify the position you required at the time of ordering.

The position of the gearbox is always defined when viewed from the suction tube end of the pump

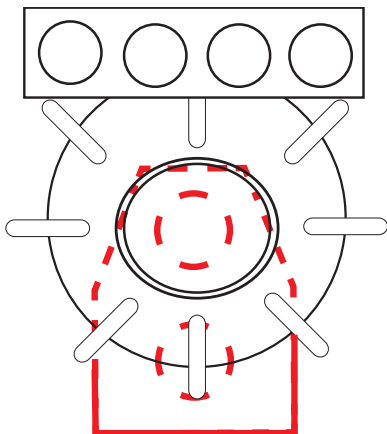

Gearbox in **DOWN** position

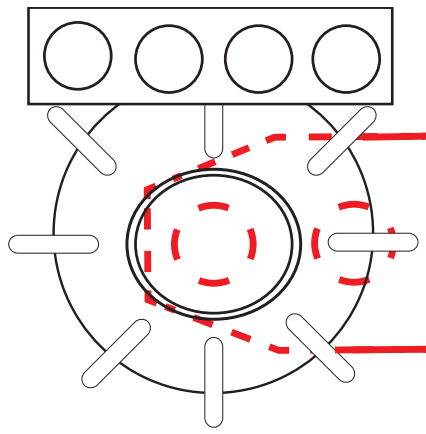

Gearbox in **RIGHT** position

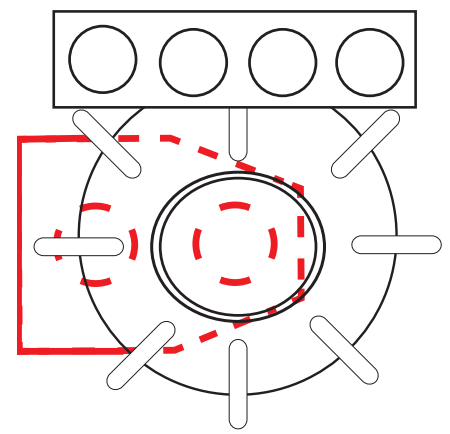

Gearbox in **Left** position

## 8. Appendix - KP Product Requirement Specification Form

<div style="background-color: #0056b3; color: white; padding: 5px; display: inline-block; font-weight: bold;">KP Series Pumps</div>		<b>PRODUCT REQUIREMENT SPECIFICATION FORM</b>	
		Form#	21/032-6
		Option available	
		Option incompatible & not available	
CUSTOMER:			
ORDER No:		SIGNED:	
DATE:			
PUMP MATERIAL	ALUM BRONZE		
PUMP RATING	750 AT 10 BAR 1000 AT 10 BAR 1500 AT 10 BAR 2000 AT 10 BAR		
PRIMING	NONE PISTON ESP PRIMER (Supplied loose)		
VEHICLE VOLTAGE	12V 24V		
GEARBOX RATIO & POSITION	GEARBOX DRIVE INPUT POSITION (When viewed from <u>suction end</u> of the pump)	RIGHT	
		DOWN	
		LEFT	
	RATIO	1.90:1	
		2.33:1 2.91:1	
DRIVE FLANGE	1410 DIN 100		
DRIVE ROT'N (Viewed on drive flange)	CLOCKWISE ROTATION (STANDARD) COUNTER CLOCKWISE ROTATION		
VOLUTE OUTLET POSITION	OUTLET POINTING UP OUTLET POINTING LEFT OUTLET POINTING RIGHT		
SUCTION INLET	DIN 175 / DN100 FLANGE (STANDARD)		
	4" BSRT		
	4½" BSP		
	4½" VICTAULIC		
	110MM STORZ		
TRV	NONE 42° C 74° C		
TANK TO PUMP INLET	NONE LHS		
MANIFOLD & OUTRIGGER ELBOWS	NONE 2 WAY MANIFOLD ONLY 2 WAY MANIFOLD FITTED WITH (2) OUTRIGGER ELBOWS		
DELIVERY VALVES	NONE 2 x UK SDV 2 x CONTINENTAL SDV 2 x BALL VALVES 2 x DUAL FLOW VALVES		
OPERATION	HANDWHEEL CRANK HANDLE (not available on ball valve)		
OUTLET CONNECTION	2½" I/C		
	2½" BSP		
	65mm STORZ		
	75mm STORZ		
FOAM SYSTEM	NONE RTP (120l/min) - SUPPLIED LOOSE		
COLOUR	POST OFFICE RED (Standard) OTHER COLOUR (Please Specify):		
OTHER SPECIAL REQUIREMENTS:		If in doubt - ASK. Tel: +44 (0)1926 623600	
MODEL No:		SIGNED:	DATE:
CHECKED, PLANNING:	DATE:	CHECKED, ACCOUNTS:	DATE:

Contact Godiva on Telephone +44 (0)1926 623600, email godiva@idexcorp.com

CONFIDENTIAL & PROPRIETARY TO GODIVA LTD.

---

## 9. Opening Letters of Credit for goods ordered on Godiva Ltd.

---

These are the requirements for opening Letters of Credit for goods ordered on Godiva Ltd.

Unless specifically agreed otherwise, the following procedure should be followed to open a Letter of Credit (L/C):-

- 1) All L/Cs should be irrevocable and confirmed by a UK bank, payable at sight at the counters of a UK bank upon presentation of correct documentation.
- 2) Please raise L/C in the name of **GODIVA LTD, CHARLES STREET, WARWICK, ENGLAND**. Do not show telephone numbers, etc.
- 3) Documents – we provide as standard an invoice & transport document. If additional documents are required which have not been quoted, we reserve the right to recover our costs.
- 4) Please keep the number of documents required to a minimum. Separate shipping weight & packing lists are not normally provided but relevant details are always included on the invoice.
- 5) Please ensure that the description of the goods ordered is accurate and kept to a **brief summary** and that shipping terms match the value of the credit, e.g. you do not call for “freight prepaid” if the value of the credit is “ex works.”
- 6) Please ensure that L/C does not prohibit the provision of photocopied documents.
- 7) Please note, **ALL** negotiable documents must be submitted via the advising bank. Under no circumstances will any negotiable documents be forwarded to you direct.
- 8) Unless expressly prohibited by local legislation, please allow transshipment on the L/C. This will allow us to dispatch more quickly. If your chosen method of dispatch is by **consolidated air freight**, the L/C **must** allow both transshipment and **House airway bills**.
- 9) Any goods of USA (Hale / Class1) origin, will not qualify for “preferential trade” status with the EU and therefore EUR1/ ATR1 etc. documentation CANNOT be issued. Please ensure that such documents are NOT called for on L/C.
- 10) Letters of Credit should be valid for shipment for at least a **further** 28 days after the acknowledged due date to allow us to arrange shipment and obtain documentation. Validity for negotiation of documents should be 21 days after shipment date.
- 11) We have no preferences as to the UK bank used – please allow your bank to select their own corresponding bank in the UK as this will minimise your bank charges.
- 12) Lead-times for orders with L/C as agreed payment will have – by default – a minimum 6-week lead-time, regardless of the product offered. It is incumbent on you to ensure that once we have received your order, the “draft” L/C is issued to Godiva Customer Service for review at least 4-weeks prior to the order promise date. The final L/C is then to be in place either 2-weeks prior to the order due date OR at the end of the calendar month prior to due date – whichever is the earlier.

**COMPLIANCE WITH THE ABOVE CONDITIONS WILL ENABLE US TO TRANSACT YOUR ORDERS WITHOUT DELAY.**

---

## 10. Customer Support Documents

---

### Customer Support Documents

To find these Godiva documents -

Contact Customer Service

[Click here for details](#)

[www.godiva.co.uk/customer-support/](http://www.godiva.co.uk/customer-support/)



Warranty Statement

[Click here for details](#)

[www.godiva.co.uk/warranty\\_statement](http://www.godiva.co.uk/warranty_statement)



Warranty Claim Form

[Click here for details](#)

[www.godiva.co.uk/customer-support-warranty-claim/](http://www.godiva.co.uk/customer-support-warranty-claim/)



Godiva terms and Conditions of Sale

[Click here for details](#)

<https://www.godiva.co.uk/customer-support-terms-conditions/>





**Issue 1, 1/2021**  
**P/N 34-068-1**

